

# ECS-4500 USER

Intel® Core™ i7/i5/i3 SoC Slim Fanless Embedded System  
IEEE 802.3at PD/PoE<sup>+</sup>, High Performance, Rugged, -25°C to 70°C

# Manual

## Record of Revision

---

Version	Date	Page	Description	Remark
1.0	03/31/2017	All	Official Release	
1.1	12/26/2018	All	Update	
1.2	03/19/2021	3, 5, 7, 9, 11, 13, 29	Update	
1.3	06/07/2023	All	Update	

## Disclaimer

This manual is released by Vecow Co., Ltd. for reference purpose only. All product offerings and specifications are subject to change without prior notice. It does not represent commitment of Vecow Co., Ltd. Vecow shall not be liable for direct, indirect, special, incidental, or consequential damages arising out of the use of the product or documentation or any infringements upon the rights of third parties, which may result from such use.

## Declaration of Conformity

**FCC** This equipment has been tested and found to comply with the limits for a Class A digital device, pursuant to part 15 of the FCC Rules. These limits are designed to provide reasonable protection against harmful interference when the equipment is operated in a commercial environment. This equipment generates, uses, and can radiate radio frequency energy, and if it is not installed and used in accordance with the instruction manual, it may cause harmful interference to radio communications. Operation of this equipment in a residential area is likely to cause harmful interference in which case the user will be required to correct the interference at his own expense.

**CE** The products described in this manual complies with all applicable European Union (CE) directives if it has a CE marking. For computer systems to remain CE compliant, only CE-compliant parts may be used. Maintaining CE compliance also requires proper cable and cabling techniques.

## Copyright and Trademarks

This document contains proprietary information protected by copyright. No part of this publication may be reproduced in any form or by any means, electric, photocopying, recording or otherwise, without prior written authorization by Vecow Co., Ltd. The rights of all the brand names, product names, and trademarks belong to their respective owners.

# Order Information

Part Number	Description
ECS-4500-PoER7600U	ECS-4500, Intel® Core™ i7-7600U Processor, 6 GigE LAN w/4 PoE+, 2 SSD Tray, 5 USB 3.0, 4 COM, 2 SIM, 16 Isolated DIO, 16 GPIO
ECS-4500-PoER600U	ECS-4500, Intel® Core™ i7-6600U Processor, 6 GigE LAN w/4 PoE+, 2 SSD Tray, 5 USB 3.0, 4 COM, 2 SIM, 16 Isolated DIO, 16 GPIO
ECS-4500-PoER300U	ECS-4500, Intel® Core™ i5-6300U Processor, 6 GigE LAN w/4 PoE+, 2 SSD Tray, 5 USB 3.0, 4 COM, 2 SIM, 16 Isolated DIO, 16 GPIO
ECS-4500-PoER955U	ECS-4500, Intel® Celeron® 3955U Processor, 6 GigE LAN w/4 PoE+, 2 SSD Tray, 5 USB 3.0, 4 COM, 2 SIM, 16 Isolated DIO, 16 GPIO
ECS-4500-PoE7600U	ECS-4500, Intel® Core™ i7-7600U Processor, 6 GigE LAN w/4 PoE+, 5 USB 3.0, 4 COM, 2 SIM, 16 Isolated DIO, 16 GPIO
ECS-4500-PoE600U	ECS-4500, Intel® Core™ i7-6600U Processor, 6 GigE LAN w/4 PoE+, 5 USB 3.0, 4 COM, 2 SIM, 16 Isolated DIO, 16 GPIO
ECS-4500-PoE300U	ECS-4500, Intel® Core™ i5-6300U Processor, 6 GigE LAN w/4 PoE+, 5 USB 3.0, 4 COM, 2 SIM, 16 Isolated DIO, 16 GPIO
ECS-4500-PoE955U	ECS-4500, Intel® Celeron® 3955U Processor, 6 GigE LAN w/4 PoE+, 5 USB 3.0, 4 COM, 2 SIM, 16 Isolated DIO, 16 GPIO
ECS-4500-PDR600U	ECS-4500, Intel® Core™ i7-6600U Processor, 2 GigE PD LAN, 2 SSD Tray, 5 USB 3.0, 4 COM, 2 SIM, 32 GPIO
ECS-4500-PDR300U	ECS-4500, Intel® Core™ i5-6300U Processor, 2 GigE PD LAN, 2 SSD Tray, 5 USB 3.0, 4 COM, 2 SIM, 32 GPIO
ECS-4500-PDR955U	ECS-4500, Intel® Celeron® 3955U Processor, 2 GigE PD LAN, 2 SSD Tray, 5 USB 3.0, 4 COM, 2 SIM, 32 GPIO
ECS-4500-PD600U	ECS-4500, Intel® Core™ i7-6600U Processor, 2 GigE PD LAN, 5 USB 3.0, 4 COM, 2 SIM, 32 GPIO
ECS-4500-PD300U	ECS-4500, Intel® Core™ i5-6300U Processor, 2 GigE PD LAN, 5 USB 3.0, 4 COM, 2 SIM, 32 GPIO
ECS-4500-PD955U	ECS-4500, Intel® Celeron® 3955U Processor, 2 GigE PD LAN, 5 USB 3.0, 4 COM, 2 SIM, 32 GPIO
ECS-4500-2R600U	ECS-4500, Intel® Core™ i7-6600U Processor, 2 GigE LAN, 2 SSD Tray, 5 USB 3.0, 4 COM, 2 SIM, 32 GPIO
ECS-4500-2R300U	ECS-4500, Intel® Core™ i5-6300U Processor, 2 GigE LAN, 2 SSD Tray, 5 USB 3.0, 4 COM, 2 SIM, 32 GPIO
ECS-4500-2R955U	ECS-4500, Intel® Celeron® 3955U Processor, 2 GigE LAN, 2 SSD Tray, 5 USB 3.0, 4 COM, 2 SIM, 32 GPIO
ECS-4500-2G600U	ECS-4500, Intel® Core™ i7-6600U Processor, 2 GigE LAN, 5 USB 3.0, 4 COM, 2 SIM, 32 GPIO
ECS-4500-2G300U	ECS-4500, Intel® Core™ i5-6300U Processor, 2 GigE LAN, 5 USB 3.0, 4 COM, 2 SIM, 32 GPIO
ECS-4500-2G955U	ECS-4500, Intel® Celeron® 3955U Processor, 2 GigE LAN, 5 USB 3.0, 4 COM, 2 SIM, 32 GPIO

## Order Accessories

---

Part Number	Description
DDR4 32G	Certified DDR4 32GB 2666MHz RAM
DDR4 16G	Certified DDR4 16GB 2133MHz RAM
DDR4 8G	Certified DDR4 8GB 2133MHz RAM
DDR4 4G	Certified DDR4 4GB 2133MHz RAM
PWA-160W-WT	160W, 24V, 85V AC to 264V AC Power Adapter with 3-pin Terminal Block, Wide Temperature -30°C to +70°C
PWA-120WM4P	120W, 24V, 90V AC to 264V AC Power Adapter with 4-pin Mini-DIN Connector
PWA-120W	120W, 24V, 90V AC to 264V AC Power Adapter with 3-pin Terminal Block
VESA Mount	VESA Mounting Kit
DIN-RAIL	DIN Rail Kit
Rack Mount	2U Rackmount Kit
TMK2-20P-100	Terminal Block 20-pin to Terminal Block 20-pin Cable, 100cm
TMK2-20P-500	Terminal Block 20-pin to Terminal Block 20-pin Cable, 500cm
TMB-TMBK-20P	Terminal Board with One 20-pin Terminal Block Connector and DIN-Rail Mounting
4G Module	Mini PCIe 4G/GPS Module with Antenna
WiFi & Bluetooth Module	WiFi & Bluetooth Module with dual band Antenna

# Table of Contents

<b>CHAPTER 1</b>	<b>GENERAL INTRODUCTION</b>	<b>1</b>
1.1	Overview	1
1.2	Features	2
1.3	Product Specification	2
1.3.1	Specifications of ECS-4500-PoER	2
1.3.2	Specifications of ECS-4500-PoE	4
1.3.3	Specifications of ECS-4500-PDR	6
1.3.4	Specifications of ECS-4500-PD	8
1.3.5	Specifications of ECS-4500-2R	10
1.3.6	Specifications of ECS-4500-2G	12
1.4	Supported CPU List	14
1.5	Mechanical Dimension	15
1.5.1	Dimensions of ECS-4500-PoER	15
1.5.2	Dimensions of ECS-4500-PoE	15
1.5.3	Dimensions of ECS-4500-PDR	15
1.5.4	Dimensions of ECS-4500-PD	16
1.5.5	Dimensions of ECS-4500-2R	16
1.5.6	Dimensions of ECS-4500-2G	16
<b>CHAPTER 2</b>	<b>GETTING TO KNOW YOUR ECS-4500</b>	<b>17</b>
2.1	Packing List	17
2.2	Front Panel I/O Functions	18
2.3	Rear Panel I/O and Functions	24
2.4	Main Board Expansion Connectors	30
2.5	Main Board Jumper & DIP Switch Settings	42
2.6	Ignition Control	46
<b>CHAPTER 3</b>	<b>SYSTEM SETUP</b>	<b>50</b>
3.1	How to Open Your ECS-4500	50
3.2	Installing DDR4 SO-DIMM Modules	52

3.3	Installing Mini PCIe Card	53
3.4	Installing Antenna Cable	54
3.5	Installing CFast Card	55
3.6	Installing SIM Card	56
3.7	Installing SSD/ HDD	57
3.8	Mounting Your ECS-4500	60
<b>CHAPTER 4</b>	<b>BIOS SETUP</b>	<b>63</b>
4.1	Entering BIOS SETUP	63
4.2	Main	64
4.3	Advanced	64
4.4	Chipset	75
4.5	Security	79
4.6	Boot	80
4.7	Save & Exit	81
<b>APPENDIX A</b>	<b>Isolated DIO Guide</b>	<b>82</b>
<b>APPENDIX B</b>	<b>GPIO_WDT Functions</b>	<b>85</b>
<b>APPENDIX C</b>	<b>RAID Functions</b>	<b>88</b>
<b>APPENDIX D</b>	<b>Power Consumption</b>	<b>92</b>
<b>APPENDIX E</b>	<b>Supported Memory &amp; Storage List</b>	<b>96</b>
<b>APPENDIX F</b>	<b>Install Win11 (BIOS TPM Setting)</b>	<b>98</b>

# 1

## GENERAL INTRODUCTION

### 1.1 Overview

Vecow ECS-4500 Series is an innovative all-in-one integrated Slim Fanless Embedded System. Powered by Intel® Core™ i7/i5/i3 U-series SoC (Kaby Lake-U/Skylake-U), dual channel DDR4 2400/2133 MHz up to 64GB ECC memory, ECS-4500 Series serves up to 10% CPU performance enhancements than the former generation SoC solution lower CPU power consumption; Advanced Intel® HD Graphics 520 graphics engine supports DirectX 12, OpenGL 4.4 and OpenCL 2.0 API, onboard DVI-D and DisplayPort display interfaces support up to ultra HD 4K resolution, ECS-4500 offers up to 34% improved graphics performance than the former generation; Multiple Gen 3 PCIe (8GT/s), SATA III (6Gbps), USB 3.0 (5Gbps), GigE (1Gbps) LAN and flexible 3G/4G/WiFi/LTE/GPS/GPRS/UMTS wireless connections make high-speed data conveying possible.

All-in-one and cable-less designs, fanless -25°C to 70°C operating temperature, innovative 2 independent GigE LAN ports supporting IEEE 802.3at Powered Device (PD), 6 GigE LAN ports with 4 IEEE 802.3at (25.5W/48V) PoE+ without additional power connections, 2 Front-access 2.5" SSD/HDD trays, 2 SIM card sockets for 3G/4G/LTE/ WiFi/GPRS/UMTS, 1 Front-access CFast socket, 2 SATA III supports software RAID function, 5 external USB 3.0, 4 COM RS-232/422/485, 2 Mini PCIe expansions, 16 Isolated DIO, 6V to 36V wide range power input with 80V surge protection, configurable ignition power control, smart remote management features, remote power switch, EN50155 and EN50121-3-2 compliant, Vecow ECS-4500 Series Slim Fanless Embedded System is an all-in-one integrated solution for rugged embedded applications.

With outstanding performance, remarkable power productivity, smart manageability, mobile availability, secure power protection, and extremely rugged reliability, Vecow ECS-4500 Series Slim Fanless Embedded System is your great solution for Machine Vision, Intelligent Automation, Smart Manufacturing, Intelligent Surveillance, Vehicle Computing, Mobile NVR/DVR, and any performance-driven real-time Industry 4.0/IIoT applications in harsh environments.



## 1.2 Features

- Intel® Core™ i7/i5/i3 U-series SoC (Kaby Lake-U/Skylake-U)
- 2 GigE LAN with IEEE 802.3at Powered Device (PD)
- 6 GigE LAN with 4 IEEE 802.3at PoE<sup>+</sup>, Power on/off enabled, iAMT 11.0 supported
- Slim design, Fanless, -25°C to 70°C Operating Temperature
- 2 DDR4 2133MHz Memory, up to 32GB
- DVI-D and dual DisplayPort display interfaces, up to 4K display
- 2 Mini PCIe support 3G/4G/LTE/WiFi/GPRS/UMTS
- Front-access : 2 2.5" SSD Tray, 2 SIM Socket, 1 CFast Socket
- 5 USB 3.0, 4 RS-232/422/485 COM, 2 SATA III, 1 mSATA
- 16 Isolated DIO with NPN/PNP, 16 GPIO
- 6V to 36V DC Power Input with 80V Surge Protection
- Configurable Ignition Power Control with Smart Battery Protection

## 1.3 Product Specification

### 1.3.1 Specifications of ECS-4500-PoER

System	
Processor	Intel® Core™ i7-7600U/i7-6600U/i5-6300U/Celeron® 3955U Processor (Kaby Lake-U/Skylake-U)
Chipset	Intel® SoC
BIOS	AMI
SIO	IT8786E
Memory	<ul style="list-style-type: none"> <li>• DDR4 2400/2133 MHz</li> <li>• Up to 64GB</li> <li>• 2 260-pin SO-DIMM Socket</li> </ul>
I/O Interface	
Serial	4 COM RS-232/422/485 w/auto flow control (ESD 8KV)
USB	<ul style="list-style-type: none"> <li>• 5 USB 3.0 (External)</li> <li>• 3 USB 2.0 (Internal)</li> </ul>
Isolated DIO	16 Isolated DIO (8 DI, 8 DO) , support NPN/PNP
GPIO	16 GPIO
LED	Power, HDD, Wireless, PoE
SIM Card	2 SIM Card Socket (External)
Expansion	
Mini PCIe	2 Mini PCIe Socket : <ul style="list-style-type: none"> <li>• 1 Full-size for PCIe/USB/External SIM Card</li> <li>• 1 Full-size for PCIe/USB/External SIM Card/mSATA</li> </ul>

<b>Graphics</b>	
Graphics Processor	Intel® HD Graphics 520
Interface	<ul style="list-style-type: none"> <li>• DVI-D : Up to 1920 x 1200 @ 60Hz</li> <li>• DisplayPort 1 : Up to 4096 x 2304 @ 60Hz</li> <li>• DisplayPort 2 : Up to 4096 x 2304 @ 60Hz</li> </ul>
<b>Storage</b>	
SATA	2 SATA III (6Gbps) support S/W RAID 0, 1
mSATA	1 SATA III (Mini PCIe Type, 6Gbps)
Storage Device	<ul style="list-style-type: none"> <li>• 1 CFast Socket, Push-in/Push-out Ejector</li> <li>• 2 Front-access 2.5" SSD/HDD Tray</li> </ul>
<b>Audio</b>	
Audio Codec	Realtek ALC888S-VD, 7.1 Channel HD Audio
Audio Interface	1 Mic-in, 1 Line-out
<b>Ethernet</b>	
LAN 1	Intel® I219LM GigE LAN supports iAMT 11.0
LAN 2	Intel® I210 GigE LAN
<b>PoE</b>	
LAN 3	GigE IEEE 802.3at (25.5W/48V) PoE <sup>+</sup> by Intel® I210
LAN 4	GigE IEEE 802.3at (25.5W/48V) PoE <sup>+</sup> by Intel® I210
LAN 5	GigE IEEE 802.3at (25.5W/48V) PoE <sup>+</sup> by Intel® I210
LAN 6	GigE IEEE 802.3at (25.5W/48V) PoE <sup>+</sup> by Intel® I210
<b>Power</b>	
Input Voltage	6V to 36V, DC-in
Power Interface	<ul style="list-style-type: none"> <li>• 3-pin Terminal Block : V+, V-, Frame Ground</li> <li>• Mini-DIN 4-pin</li> </ul>
Ignition Control	16 Mode (Internal)
Remote Switch	3-pin Terminal Block : On, Off, IGN
Surge Protection	Up to 80V/1ms Transient Power
<b>Others</b>	
TPM	Optional Infineon SLB9665 supports TPM 2.0, LPC interface
Watchdog Timer	Reset : 1 to 255 sec./min. per step
Smart Management	Wake on LAN, PXE supported
HW Monitor	Monitoring temperature, voltages. Auto throttling control when CPU overheats.
<b>Software Support</b>	
OS	Windows 10, Windows 8.1, Windows 7, Linux

<b>Mechanical</b>	
Dimensions (WxDxH)	257mm x 141mm x 48mm (10.1" x 5.6" x 1.9")
Weight	2.1 kg (4.6 lb)
Mounting	<ul style="list-style-type: none"> <li>• Wallmount by mounting bracket</li> <li>• DIN Rail Mount (Optional)</li> <li>• 2U Rackmount (Optional)</li> </ul>
<b>Environment</b>	
Operating Temperature	-25°C to 70°C (-13°F to 158°F)
Storage Temperature	-40°C to 85°C (-40°F to 185°F)
Humidity	5% to 95% Humidity, non-condensing
Relative Humidity	95% at 70°C
Shock	<ul style="list-style-type: none"> <li>• IEC 60068-2-27</li> <li>• SSD : 50G @ Wallmount, Half-sine, 11ms</li> </ul>
Vibration	<ul style="list-style-type: none"> <li>• IEC 60068-2-64</li> <li>• SSD : 5Grms, 5Hz to 500Hz, 3 Axis</li> </ul>
EMC	CE, FCC, EN50155, EN50121-3-2

### 1.3.2 Specifications of ECS-4500-PoE

<b>System</b>	
Processor	Intel® Core™ i7-7600U/i7-6600U/i5-6300U/Celeron® 3955U Processor (Kaby Lake-U/Skylake-U)
Chipset	Intel® SoC
BIOS	AMI
SIO	IT8786E
Memory	<ul style="list-style-type: none"> <li>• DDR4 2400/2133 MHz</li> <li>• Up to 64GB</li> <li>• 2 260-pin SO-DIMM Socket</li> </ul>
<b>I/O Interface</b>	
Serial	4 COM RS-232/422/485 w/auto flow control (ESD 8KV)
USB	<ul style="list-style-type: none"> <li>• 5 USB 3.0 (External)</li> <li>• 3 USB 2.0 (Internal)</li> </ul>
Isolated DIO	16 Isolated DIO (8 DI, 8 DO) , support NPN/PNP
GPIO	16 GPIO
LED	Power, HDD, Wireless, PoE
SIM Card	2 SIM Card Socket (External)

<b>Expansion</b>	
Mini PCIe	2 Mini PCIe Socket : <ul style="list-style-type: none"> <li>• 1 Full-size for PCIe/USB/External SIM Card</li> <li>• 1 Full-size for PCIe/USB/External SIM Card/mSATA</li> </ul>
<b>Graphics</b>	
Graphics Processor	Intel® HD Graphics 520
Interface	<ul style="list-style-type: none"> <li>• DVI-D : Up to 1920 x 1200 @ 60Hz</li> <li>• DisplayPort 1 : Up to 4096 x 2304 @ 60Hz</li> <li>• DisplayPort 2 : Up to 4096 x 2304 @ 60Hz</li> </ul>
<b>Storage</b>	
SATA	2 SATA III (6Gbps) support S/W RAID 0, 1
mSATA	1 SATA III (Mini PCIe Type, 6Gbps)
Storage Device	<ul style="list-style-type: none"> <li>• 1 CFast Socket, Push-in/Push-out Ejector</li> <li>• 2 2.5" SSD/HDD Bracket (Internal)</li> </ul>
<b>Audio</b>	
Audio Codec	Realtek ALC888S-VD, 7.1 Channel HD Audio
Audio Interface	1 Mic-in, 1 Line-out
<b>Ethernet</b>	
LAN 1	Intel® I219LM GigE LAN supports iAMT 11.0
LAN 2	Intel® I210 GigE LAN
<b>PoE</b>	
LAN 3	GigE IEEE 802.3at (25.5W/48V) PoE <sup>+</sup> by Intel® I210
LAN 4	GigE IEEE 802.3at (25.5W/48V) PoE <sup>+</sup> by Intel® I210
LAN 5	GigE IEEE 802.3at (25.5W/48V) PoE <sup>+</sup> by Intel® I210
LAN 6	GigE IEEE 802.3at (25.5W/48V) PoE <sup>+</sup> by Intel® I210
<b>Power</b>	
Input Voltage	6V to 36V, DC-in
Power Interface	<ul style="list-style-type: none"> <li>• 3-pin Terminal Block : V+, V-, Frame Ground</li> <li>• Mini-DIN 4-pin</li> </ul>
Ignition Control	16 Mode (Internal)
Remote Switch	3-pin Terminal Block : On, Off, IGN
Surge Protection	Up to 80V/1ms Transient Power
<b>Others</b>	
TPM	Optional Infineon SLB9665 supports TPM 2.0, LPC interface
Watchdog Timer	Reset : 1 to 255 sec./min. per step
Smart Management	Wake on LAN, PXE supported

HW Monitor	Monitoring temperature, voltages. Auto throttling control when CPU overheats.
<b>Software Support</b>	
OS	Windows 10, Windows 8.1, Windows 7, Linux
<b>Mechanical</b>	
Dimensions (WxDxH)	257mm x 141mm x 48mm (10.1" x 5.6" x 1.9")
Weight	2.1 kg (4.6 lb)
Mounting	<ul style="list-style-type: none"> <li>• Wallmount by mounting bracket</li> <li>• DIN Rail Mount (Optional)</li> <li>• 2U Rackmount (Optional)</li> </ul>
<b>Environment</b>	
Operating Temperature	-25°C to 70°C (-13°F to 158°F)
Storage Temperature	-40°C to 85°C (-40°F to 185°F)
Humidity	5% to 95% Humidity, non-condensing
Relative Humidity	95% at 70°C
Shock	<ul style="list-style-type: none"> <li>• IEC 60068-2-27</li> <li>• SSD : 50G @ Wallmount, Half-sine, 11ms</li> </ul>
Vibration	<ul style="list-style-type: none"> <li>• IEC 60068-2-64</li> <li>• SSD : 5Grms, 5Hz to 500Hz, 3 Axis</li> </ul>
EMC	CE, FCC, EN50155, EN50121-3-2

### 1.3.3 Specifications of ECS-4500-PDR

<b>System</b>	
Processor	Intel® Core™ i7-6600U/i5-6300U/Celeron® 3955U Processor (Skylake-U)
Chipset	Intel® SoC
BIOS	AMI
SIO	IT8786E
Memory	<ul style="list-style-type: none"> <li>• DDR4 2133MHz</li> <li>• Up to 64GB</li> <li>• 2 260-pin SO-DIMM Socket</li> </ul>
<b>I/O Interface</b>	
Serial	4 COM RS-232/422/485 w/auto flow control (ESD 8KV)
USB	<ul style="list-style-type: none"> <li>• 5 USB 3.0 (External)</li> <li>• 3 USB 2.0 (Internal)</li> </ul>
GPIO	32 GPIO

LED	Power, HDD, Wireless, PD
SIM Card	2 SIM Card Socket (External)
<b>Expansion</b>	
Mini PCIe	2 Mini PCIe Socket : <ul style="list-style-type: none"> <li>• 1 Full-size for PCIe/USB/External SIM Card</li> <li>• 1 Full-size for PCIe/USB/External SIM Card/mSATA</li> </ul>
<b>Graphics</b>	
Graphics Processor	Intel® HD Graphics 520
Interface	<ul style="list-style-type: none"> <li>• DVI-D : Up to 1920 x 1200 @ 60Hz</li> <li>• DisplayPort 1 : Up to 4096 x 2304 @ 60Hz</li> <li>• DisplayPort 2 : Up to 4096 x 2304 @ 60Hz</li> </ul>
<b>Storage</b>	
SATA	2 SATA III (6Gbps) support S/W RAID 0, 1
mSATA	1 SATA III (Mini PCIe Type, 6Gbps)
Storage Device	<ul style="list-style-type: none"> <li>• 1 CFast Socket, Push-in/Push-out Ejector</li> <li>• 2 Front-access 2.5" SSD/HDD Tray</li> </ul>
<b>Audio</b>	
Audio Codec	Realtek ALC888S-VD, 7.1 Channel HD Audio
Audio Interface	1 Mic-in, 1 Line-out
<b>Ethernet</b>	
LAN 1	Intel® I219LM GigE LAN supports IEEE 802.3at (25.5W/48V) Powered Device (PD) and iAMT 11.0
LAN 2	Intel® I210 GigE LAN supports IEEE 802.3at (25.5W/48V) Powered Device (PD)
<b>Power</b>	
Input Voltage	6V to 36V, DC-in
Power Interface	<ul style="list-style-type: none"> <li>• 3-pin Terminal Block : V+, V-, Frame Ground</li> <li>• Mini-DIN 4-pin</li> </ul>
Ignition Control	16 Mode (Internal)
Remote Switch	3-pin Terminal Block : On, Off, IGN
Surge Protection	Up to 80V/1ms Transient Power
<b>Others</b>	
TPM	Optional Infineon SLB9665 supports TPM 2.0, LPC interface
Watchdog Timer	Reset : 1 to 255 sec./min. per step
Smart Management	Wake on LAN, PXE supported
HW Monitor	Monitoring temperature, voltages. Auto throttling control when CPU overheats.

<b>Software Support</b>	
OS	Windows 10, Windows 8.1, Windows 7, Linux
<b>Mechanical</b>	
Dimensions (WxDxH)	257mm x 141mm x 48mm (10.1" x 5.6" x 1.9")
Weight	2.1 kg (4.6 lb)
Mounting	<ul style="list-style-type: none"> <li>• Wallmount by mounting bracket</li> <li>• DIN Rail Mount (Optional)</li> <li>• 2U Rackmount (Optional)</li> </ul>
<b>Environment</b>	
Operating Temperature	-25°C to 70°C (-13°F to 158°F)
Storage Temperature	-40°C to 85°C (-40°F to 185°F)
Humidity	5% to 95% Humidity, non-condensing
Relative Humidity	95% at 70°C
Shock	<ul style="list-style-type: none"> <li>• IEC 60068-2-27</li> <li>• SSD : 50G @ Wallmount, Half-sine, 11ms</li> </ul>
Vibration	<ul style="list-style-type: none"> <li>• IEC 60068-2-64</li> <li>• SSD : 5Grms, 5Hz to 500Hz, 3 Axis</li> </ul>
EMC	CE, FCC, EN50155, EN50121-3-2

### 1.3.4 Specifications of ECS-4500-PD

<b>System</b>	
Processor	Intel® Core™ i7-6600U/i5-6300U/Celeron® 3955U Processor (Skylake-U)
Chipset	Intel® SoC
BIOS	AMI
SIO	IT8786E
Memory	<ul style="list-style-type: none"> <li>• DDR4 2133MHz</li> <li>• Up to 64GB</li> <li>• 2 260-pin SO-DIMM Socket</li> </ul>
<b>I/O Interface</b>	
Serial	4 COM RS-232/422/485 w/auto flow control (ESD 8KV)
USB	<ul style="list-style-type: none"> <li>• 5 USB 3.0 (External)</li> <li>• 3 USB 2.0 (Internal)</li> </ul>
GPIO	32 GPIO
LED	Power, HDD, Wireless, PD
SIM Card	2 SIM Card Socket (External)

<b>Expansion</b>	
Mini PCIe	2 Mini PCIe Socket : <ul style="list-style-type: none"> <li>• 1 Full-size for PCIe/USB/External SIM Card</li> <li>• 1 Full-size for PCIe/USB/External SIM Card/mSATA</li> </ul>
<b>Graphics</b>	
Graphics Processor	Intel® HD Graphics 520
Interface	<ul style="list-style-type: none"> <li>• DVI-D : Up to 1920 x 1200 @ 60Hz</li> <li>• DisplayPort 1 : Up to 4096 x 2304 @ 60Hz</li> <li>• DisplayPort 2 : Up to 4096 x 2304 @ 60Hz</li> </ul>
<b>Storage</b>	
SATA	2 SATA III (6Gbps) support S/W RAID 0, 1
mSATA	1 SATA III (Mini PCIe Type, 6Gbps)
Storage Device	<ul style="list-style-type: none"> <li>• 1 CFast Socket, Push-in/Push-out Ejector</li> <li>• 2 2.5" SSD/HDD Bracket (Internal)</li> </ul>
<b>Audio</b>	
Audio Codec	Realtek ALC888S-VD, 7.1 Channel HD Audio
Audio Interface	1 Mic-in, 1 Line-out
<b>Ethernet</b>	
LAN 1	Intel® I219LM GigE LAN supports IEEE 802.3at (25.5W/48V) Powered Device (PD) and iAMT 11.0
LAN 2	Intel® I210 GigE LAN supports IEEE 802.3at (25.5W/48V) Powered Device (PD)
<b>Power</b>	
Input Voltage	6V to 36V, DC-in
Power Interface	<ul style="list-style-type: none"> <li>• 3-pin Terminal Block : V+, V-, Frame Ground</li> <li>• Mini-DIN 4-pin</li> </ul>
Ignition Control	16 Mode (Internal)
Remote Switch	3-pin Terminal Block : On, Off, IGN
Surge Protection	Up to 80V/1ms Transient Power
<b>Others</b>	
TPM	Optional Infineon SLB9665 supports TPM 2.0, LPC interface
Watchdog Timer	Reset : 1 to 255 sec./min. per step
Smart Management	Wake on LAN, PXE supported
HW Monitor	Monitoring temperature, voltages. Auto throttling control when CPU overheats.
<b>Software Support</b>	
OS	Windows 10, Windows 8.1, Windows 7, Linux



<b>Mechanical</b>	
Dimensions (WxDxH)	257mm x 141mm x 48mm (10.1" x 5.6" x 1.9")
Weight	2.1 kg (4.6 lb)
Mounting	<ul style="list-style-type: none"> <li>• Wallmount by mounting bracket</li> <li>• DIN Rail Mount (Optional)</li> <li>• 2U Rackmount (Optional)</li> </ul>
<b>Environment</b>	
Operating Temperature	-25°C to 70°C (-13°F to 158°F)
Storage Temperature	-40°C to 85°C (-40°F to 185°F)
Humidity	5% to 95% Humidity, non-condensing
Relative Humidity	95% at 70°C
Shock	<ul style="list-style-type: none"> <li>• IEC 60068-2-27</li> <li>• SSD : 50G @ Wallmount, Half-sine, 11ms</li> </ul>
Vibration	<ul style="list-style-type: none"> <li>• IEC 60068-2-64</li> <li>• SSD : 5Grms, 5Hz to 500Hz, 3 Axis</li> </ul>
EMC	CE, FCC, EN50155, EN50121-3-2

### 1.3.5 Specifications of ECS-4500-2R

<b>System</b>	
Processor	Intel® Core™ i7-6600U/i5-6300U/Celeron® 3955U Processor (Skylake-U)
Chipset	Intel® SoC
BIOS	AMI
SIO	IT8786E
Memory	<ul style="list-style-type: none"> <li>• DDR4 2133MHz</li> <li>• Up to 64GB</li> <li>• 2 260-pin SO-DIMM Socket</li> </ul>
<b>I/O Interface</b>	
Serial	4 COM RS-232/422/485 w/auto flow control (ESD 8KV)
USB	<ul style="list-style-type: none"> <li>• 5 USB 3.0 (External)</li> <li>• 3 USB 2.0 (Internal)</li> </ul>
GPIO	32 GPIO
LED	Power, HDD, Wireless, PD
SIM Card	2 SIM Card Socket (External)

<b>Expansion</b>	
Mini PCIe	2 Mini PCIe Socket : <ul style="list-style-type: none"> <li>• 1 Full-size for PCIe/USB/External SIM Card</li> <li>• 1 Full-size for PCIe/USB/External SIM Card/mSATA</li> </ul>
<b>Graphics</b>	
Graphics Processor	Intel® HD Graphics 520
Interface	<ul style="list-style-type: none"> <li>• DVI-D : Up to 1920 x 1200 @ 60Hz</li> <li>• DisplayPort 1 : Up to 4096 x 2304 @ 60Hz</li> <li>• DisplayPort 2 : Up to 4096 x 2304 @ 60Hz</li> </ul>
<b>Storage</b>	
SATA	2 SATA III (6Gbps) support S/W RAID 0, 1
mSATA	1 SATA III (Mini PCIe Type, 6Gbps)
Storage Device	<ul style="list-style-type: none"> <li>• 1 CFast Socket, Push-in/Push-out Ejector</li> <li>• 2 Front-access 2.5" SSD/HDD Tray</li> </ul>
<b>Audio</b>	
Audio Codec	Realtek ALC888S-VD, 7.1 Channel HD Audio
Audio Interface	1 Mic-in, 1 Line-out
<b>Ethernet</b>	
LAN 1	Intel® I219LM GigE LAN supports iAMT 11.0
LAN 2	Intel® I210 GigE LAN
<b>Power</b>	
Input Voltage	6V to 36V, DC-in
Power Interface	<ul style="list-style-type: none"> <li>• 3-pin Terminal Block : V+, V-, Frame Ground</li> <li>• Mini-DIN 4-pin</li> </ul>
Ignition Control	16 Mode (Internal)
Remote Switch	3-pin Terminal Block : On, Off, IGN
Surge Protection	Up to 80V/1ms Transient Power
<b>Others</b>	
TPM	Optional Infineon SLB9665 supports TPM 2.0, LPC interface
Watchdog Timer	Reset : 1 to 255 sec./min. per step
Smart Management	Wake on LAN, PXE supported
HW Monitor	Monitoring temperature, voltages. Auto throttling control when CPU overheats.
<b>Software Support</b>	
OS	Windows 10, Windows 8.1, Windows 7, Linux

<b>Mechanical</b>	
Dimensions (WxDxH)	257mm x 141mm x 48mm (10.1" x 5.6" x 1.9")
Weight	2.1 kg (4.6 lb)
Mounting	<ul style="list-style-type: none"> <li>• Wallmount by mounting bracket</li> <li>• DIN Rail Mount (Optional)</li> <li>• 2U Rackmount (Optional)</li> </ul>
<b>Environment</b>	
Operating Temperature	-25°C to 70°C (-13°F to 158°F)
Storage Temperature	-40°C to 85°C (-40°F to 185°F)
Humidity	5% to 95% Humidity, non-condensing
Relative Humidity	95% at 70°C
Shock	<ul style="list-style-type: none"> <li>• IEC 60068-2-27</li> <li>• SSD : 50G @ Wallmount, Half-sine, 11ms</li> </ul>
Vibration	<ul style="list-style-type: none"> <li>• IEC 60068-2-64</li> <li>• SSD : 5Grms, 5Hz to 500Hz, 3 Axis</li> </ul>

### 1.3.6 Specifications of ECS-4500-2G

<b>System</b>	
Processor	Intel® Core™ i7-6600U/i5-6300U/Celeron® 3955U Processor (Skylake-U)
Chipset	Intel® SoC
BIOS	AMI
SIO	IT8786E
Memory	<ul style="list-style-type: none"> <li>• DDR4 2133MHz</li> <li>• Up to 64GB</li> <li>• 2 260-pin SO-DIMM Socket</li> </ul>
<b>I/O Interface</b>	
Serial	4 COM RS-232/422/485 w/auto flow control (ESD 8KV)
USB	<ul style="list-style-type: none"> <li>• 5 USB 3.0 (External)</li> <li>• 3 USB 2.0 (Internal)</li> </ul>
GPIO	32 GPIO
LED	Power, HDD, Wireless
SIM Card	2 SIM Card Socket (External)
<b>Expansion</b>	
Mini PCIe	2 Mini PCIe Socket : <ul style="list-style-type: none"> <li>• 1 Full-size for PCIe/USB/External SIM Card</li> <li>• 1 Full-size for PCIe/USB/External SIM Card/mSATA</li> </ul>

<b>Graphics</b>	
Graphics Processor	Intel® HD Graphics 520
Interface	<ul style="list-style-type: none"> <li>• DVI-D : Up to 1920 x 1200 @ 60Hz</li> <li>• DisplayPort 1 : Up to 4096 x 2304 @ 60Hz</li> <li>• DisplayPort 2 : Up to 4096 x 2304 @ 60Hz</li> </ul>
<b>Storage</b>	
SATA	2 SATA III (6Gbps) support S/W RAID 0, 1
mSATA	1 SATA III (Mini PCIe Type, 6Gbps)
Storage Device	<ul style="list-style-type: none"> <li>• 1 CFast Socket, Push-in/Push-out Ejector</li> <li>• 2 SSD/HDD Bracket (Internal)</li> </ul>
<b>Audio</b>	
Audio Codec	Realtek ALC888S-VD, 7.1 Channel HD Audio
Audio Interface	1 Mic-in, 1 Line-out
<b>Ethernet</b>	
LAN 1	Intel® I219LM GigE LAN supports iAMT 11.0
LAN 2	Intel® I210 GigE LAN
<b>Power</b>	
Input Voltage	6V to 36V, DC-in
Power Interface	<ul style="list-style-type: none"> <li>• 3-pin Terminal Block : V+, V-, Frame Ground</li> <li>• Mini-DIN 4-pin</li> </ul>
Ignition Control	16 Mode (Internal)
Remote Switch	3-pin Terminal Block : On, Off, IGN
Surge Protection	Up to 80V/1ms Transient Power
<b>Others</b>	
TPM	Optional Infineon SLB9665 supports TPM 2.0, LPC interface
Watchdog Timer	Reset : 1 to 255 sec./min. per step
Smart Management	Wake on LAN, PXE supported
HW Monitor	Monitoring temperature, voltages. Auto throttling control when CPU overheats.
<b>Software Support</b>	
OS	Windows 10, Windows 8.1, Windows 7, Linux
<b>Mechanical</b>	
Dimensions (WxDxH)	257mm x 141mm x 48mm (10.1" x 5.6" x 1.9")
Weight	2.1 kg (4.6 lb)
Mounting	<ul style="list-style-type: none"> <li>• Wallmount by mounting bracket</li> <li>• DIN Rail Mount (Optional)</li> <li>• 2U Rackmount (Optional)</li> </ul>

Environment	
Operating Temperature	-25°C to 70°C (-13°F to 158°F)
Storage Temperature	-40°C to 85°C (-40°F to 185°F)
Humidity	5% to 95% Humidity, non-condensing
Relative Humidity	95% at 70°C
Shock	<ul style="list-style-type: none"> <li>• IEC 60068-2-27</li> <li>• SSD : 50G @ Wallmount, Half-sine, 11ms</li> </ul>
Vibration	<ul style="list-style-type: none"> <li>• IEC 60068-2-64</li> <li>• SSD : 5Grms, 5Hz to 500Hz, 3 Axis</li> </ul>
EMC	CE, FCC, EN50155, EN50121-3-2

## 1.4 Supported CPU List

Processor No.	TDP	Cache	Max. Frequency	Embedded
i7-6600U	15W	4M	Up to 3.4 GHz	Yes
i5-6300U	15W	4M	Up to 3.0 GHz	Yes
i3-6100U	15W	4M	Up to 2.3 GHz	Yes
Celeron 3955U	15W	2M	Up to 2.0 GHz	Yes

## 1.5 Mechanical Dimension

### 1.5.1 Dimensions of ECS-4500-PoER

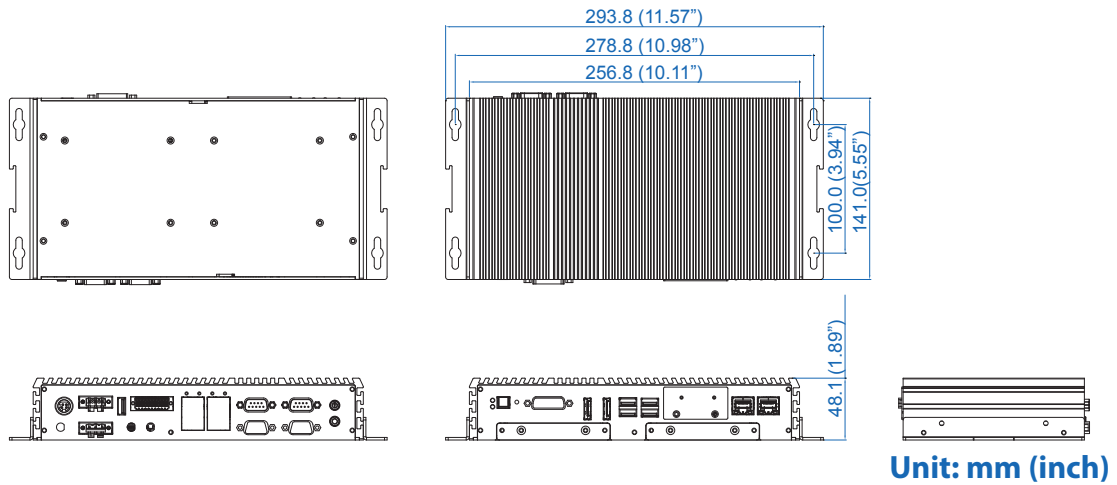

### 1.5.2 Dimensions of ECS-4500-PoE

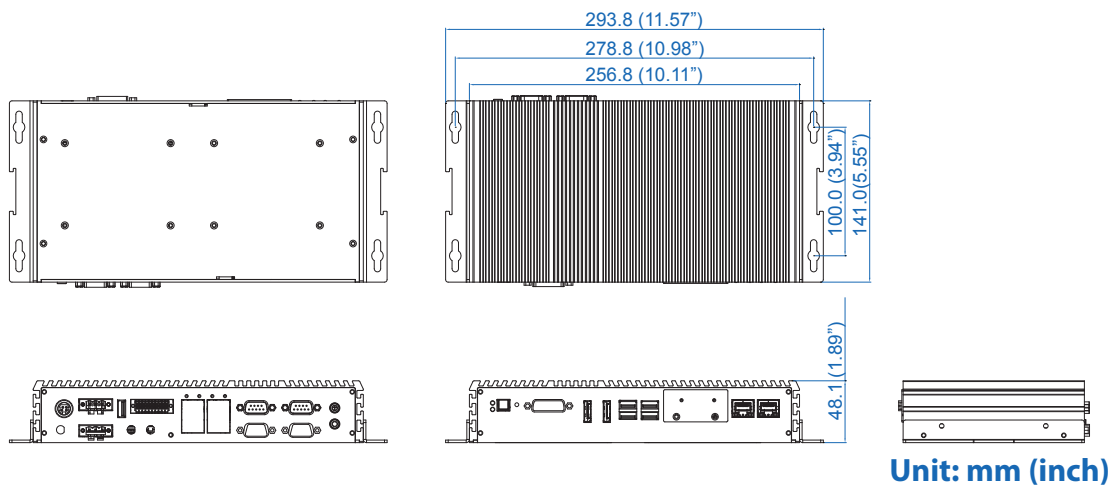

### 1.5.3 Dimensions of ECS-4500-PDR

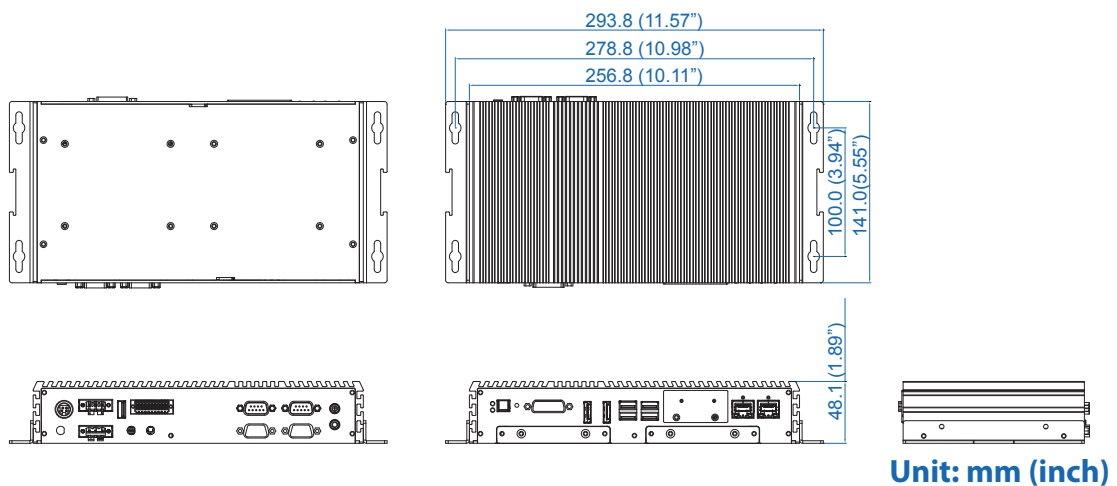

### 1.5.4 Dimensions of ECS-4500-PD

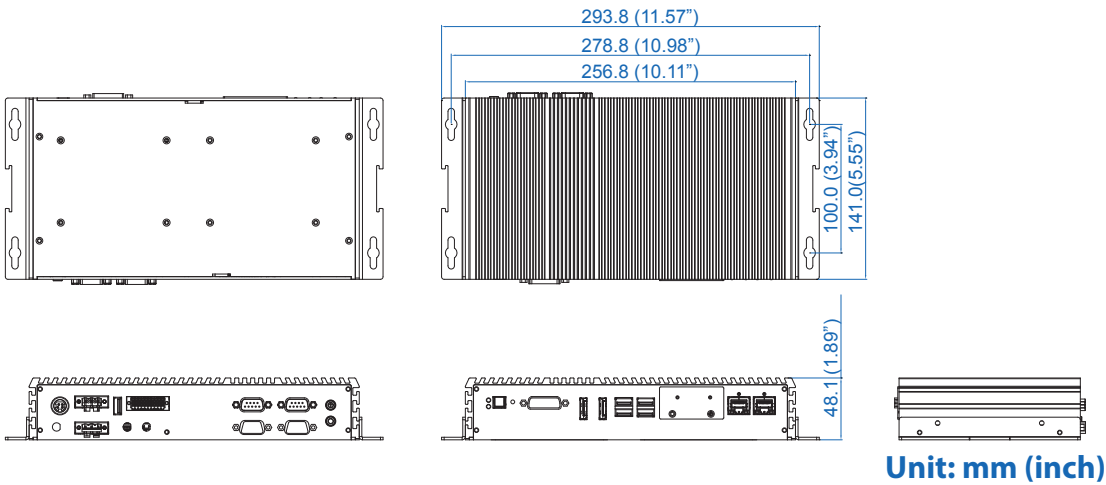

### 1.5.5 Dimensions of ECS-4500-2R

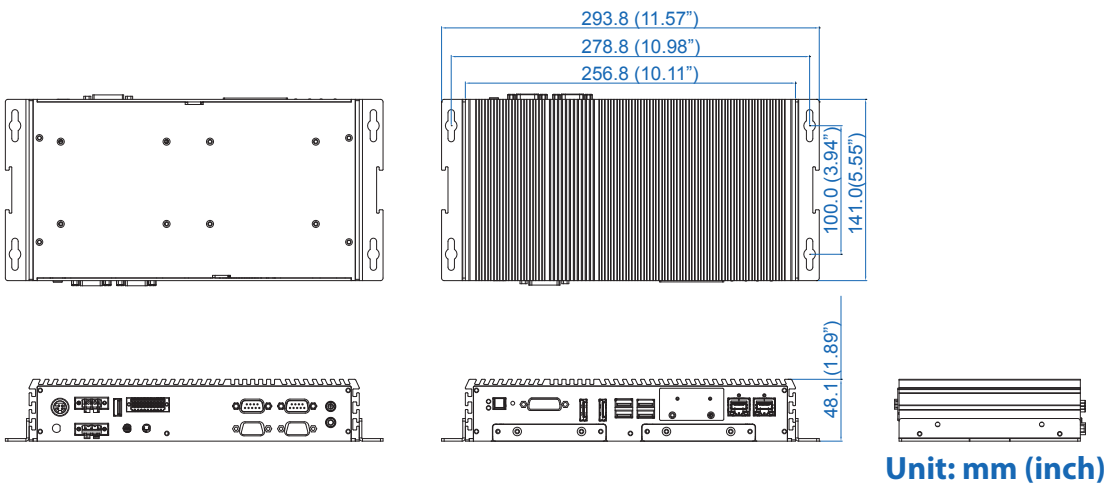

### 1.5.6 Dimensions of ECS-4500-2G

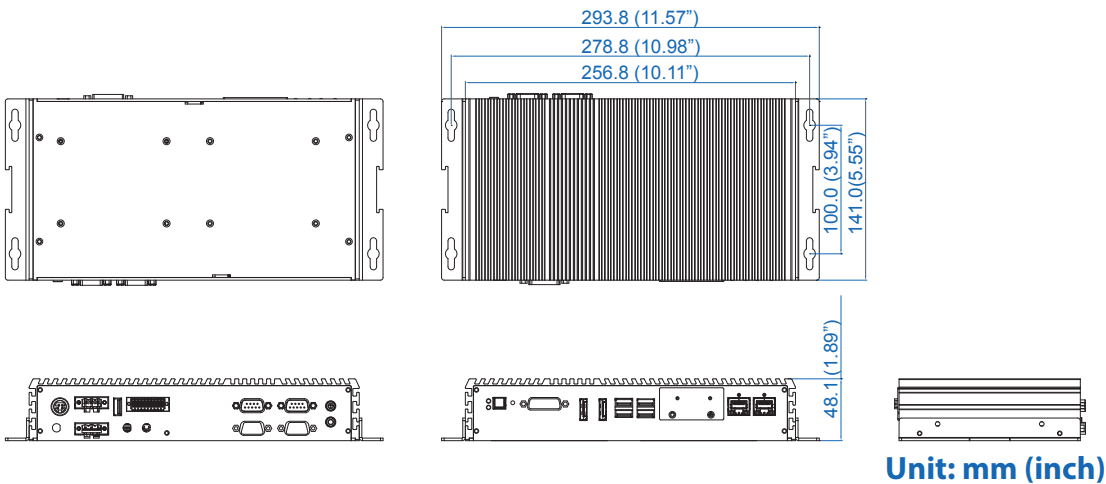

# 2

## GETTING TO KNOW YOUR ECS-4500

### 2.1 Packing List

Item	Description	Qty
1	ECS-4500 Slim Fanless Embedded System (According to the configuration of you order, the ECS-4500 series may contain SSD/HDD and DDR4 SO-DIMM. Please verify these items if necessary.)	1
2	ECS-4500-PoE/PD/2G accessory box, which contains <ul style="list-style-type: none"><li>● Wall-mounting bracket</li><li>● KHS#6-32x6 screw for wall-mounting bracket</li><li>● M2.5x6 screw for Mini PCIe Slot</li><li>● Din-Rail-PH-Mx16.5-S-Ni</li><li>● 3-pin pluggable terminal block (180°)</li><li>● 3-pin pluggable terminal block(90°)</li><li>● 20-pin pluggable terminal block</li><li>● Foot Pad</li><li>● SSD/HDD Bracket KH-M3x6L Ni</li></ul>	2 4 2 4 1 1 1 4 8
3	ECS-4500-PoER/PDR/2R accessory box, which contains <ul style="list-style-type: none"><li>● Wall-mounting bracket</li><li>● KHS#6-32x6 screw for wall-mounting bracket</li><li>● M2.5x6 screw for Mini PCIe Slot</li><li>● Din-Rail-PH-M4x16.5-S-Ni</li><li>● 3-pin pluggable terminal block (180°)</li><li>● 3-pin pluggable terminal block(90°)</li><li>● 20-pin pluggable terminal block</li><li>● Foot Pad</li><li>● SSD/HDD F-M3x4 screws</li></ul>	2 4 2 4 1 1 1 4 4



## 2.2 Front Panel I/O Functions

In Vecow ECS-4500 series family, all I/O connectors are located on front panel and rear panel. Most of the general connections to computer device, such as USB, DVI-D, DisplayPort, LAN Jack and any additional storage, are placed on the front panel.

### 2.2.1 Reset Tact Switch

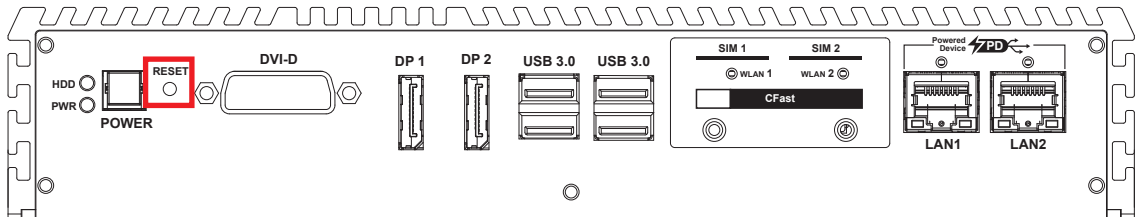

It is a hardware reset switch. Please use this switch to reset ECS-4500 without power off. Press the Reset Switch for a few seconds, and then reset will be enabled.

### 2.2.2 Power Button

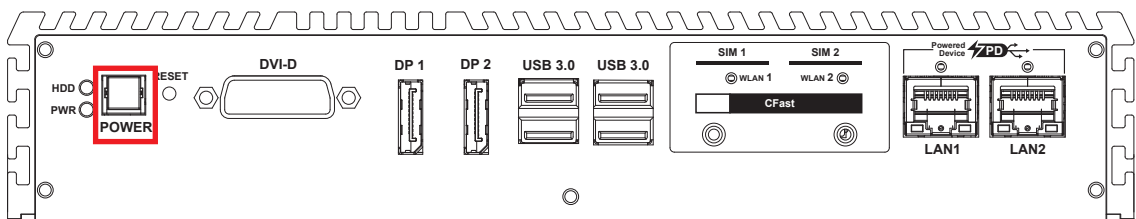

The Power Button is a non-latched switch with dual color LED indications. It indicates power status: S0, S3 and S5. More detail LED indications are listed as follows:

LED Color	Power Status	System Status
Solid Blue	S0	System working
Solid Orange	S3, S5	Suspend to RAM, System off with standby power

To power on ECS-4500, please press the power button and then the blue LED is lightened. To power off the system, you can either command shutdown by OS operation, or just simply press the power button.

If system error, you can just press the power button for 4-seconds to shut down the machine directly. Please do note that a 4-second interval between each 2 power-on/ power-off operation is necessary in normal working status. (For example, once turning off the system, you have to wait for 4 seconds to initiate another power-on operation.)

## 2.2.3 CFast Card

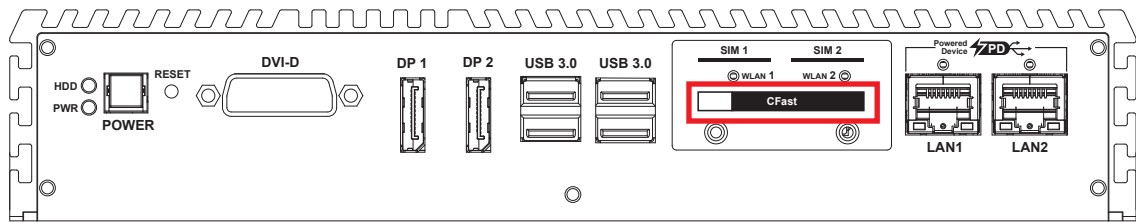

There is a CFast socket on the front panel supporting Type-I/II Compact Flash card. It is implemented by a SATA III Port from Kaby Lake-U/Skylake-U PCH. Be sure to disconnect the power source and unscrew the CFast socket cover before installing a CFast card. The ECS-4500 does not support the CFast hot swap and PnP (Plug and Play) functions. It is necessary to remove power source first before inserting or removing the CFast card.

The pinouts of CFast port are listed as follows:

Pin No.	Description	Pin No.	Description
S1	GND	PC6	NC
S2	SATA_CFAST_TXP	PC7	GND
S3	SATA_CFAST_TXN	PC8	CFAST_LED
S4	GND	PC9	NC
S5	SATA_CFAST_RXN	PC10	NC
S6	SATA_CFAST_RXP	PC11	NC
S7	GND	PC12	NC
PC1	GND	PC13	+V3P3
PC2	GND	PC14	+V3P3
PC3	NC	PC15	GND
PC4	NC	PC16	GND
PC5	NC	PC17	NC

## 2.2.4 PWR and HDD LED Indicator

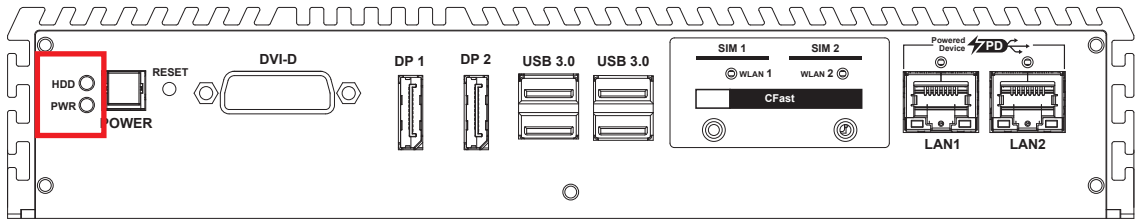

**HDD LED/Yellow** : A hard disk/CFast LED. If the LED is on, it indicates that ECS-4500 storage is functional. If it is off, it indicates that the system's storage is not functional. If it is flashing, it indicates data access activities.

**Power LED/Green** : If the LED is solid green, it indicates that the system is powered on.

LED Color	Power Status	System Status
Yellow	HDD/CFast	<ul style="list-style-type: none"> <li>On/Off : Storage status, function or not.</li> <li>Twinkling : Data transferring.</li> </ul>
Green	Power	System power status (on/off)

## 2.2.5 DVI-D Connector

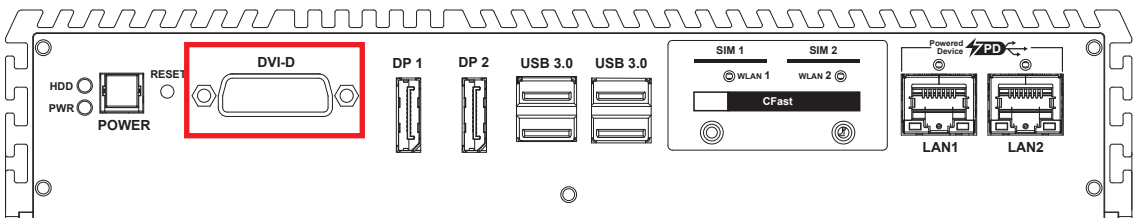

The DVI-D connector on the front panel supports DVI display modes. The DVI output mode supports up to 1920 x 1200 resolution.

## 2.2.6 DisplayPort

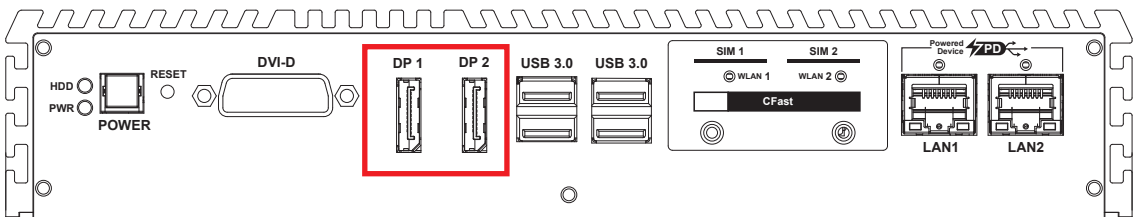

Onboard DisplayPort connection supports up to 4096 x 2304 resolutions at 60Hz. DP2 will not be enabled when ECS-4500 supports dual-channel 24-bit LVDS display.

## 2.2.7 USB3.0

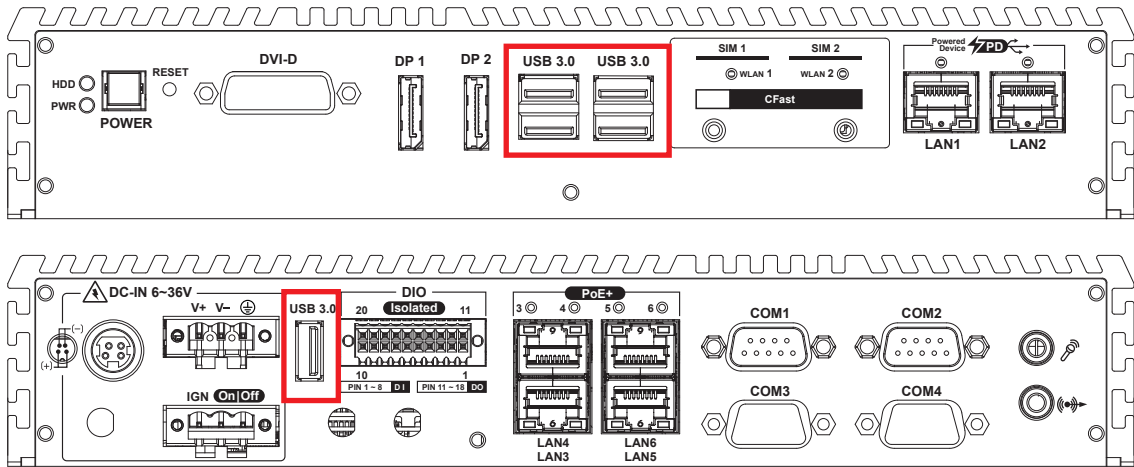

There are 5 USB 3.0 (4 in the front, 1 in the rear panel) connections available supporting up to 5GB per second data rate of ECS-4500. It is also compliant with the requirements of SuperSpeed (SS), High Speed (HS), Full Speed (FS) and Low Speed (LS).

## 2.2.8 WLAN LED, Mini PCIe, SIM Card Comparison

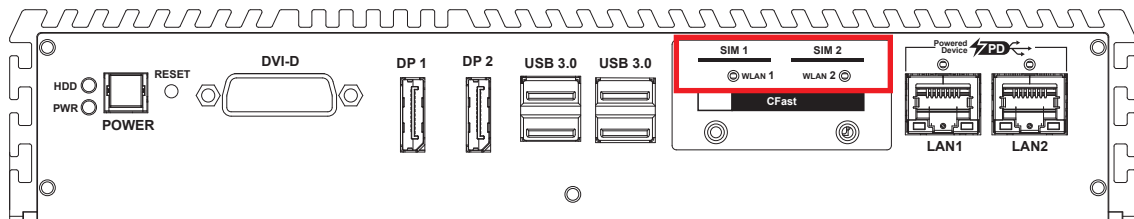

Mini PCIe Slot/SIM Slot/WLAN LED Mapping Table :

Mini PCIe	SIM	LED
Mini PCIe 1/mSATA (CN13)	SIM 1 (CN26)	1
Mini PCIe 2 (CN12)	SIM 2 (CN27)	2

Mini PCIe 1/mSATA Select SW :

Jumper (JP7)	Interface
1-2	Auto Detection
3-4	Mini PCIe
1-3	mSATA

### Note:

The SIM card sockets do not support hot-plug. Please make sure to unplug the system power before inserting the SIM card(s).

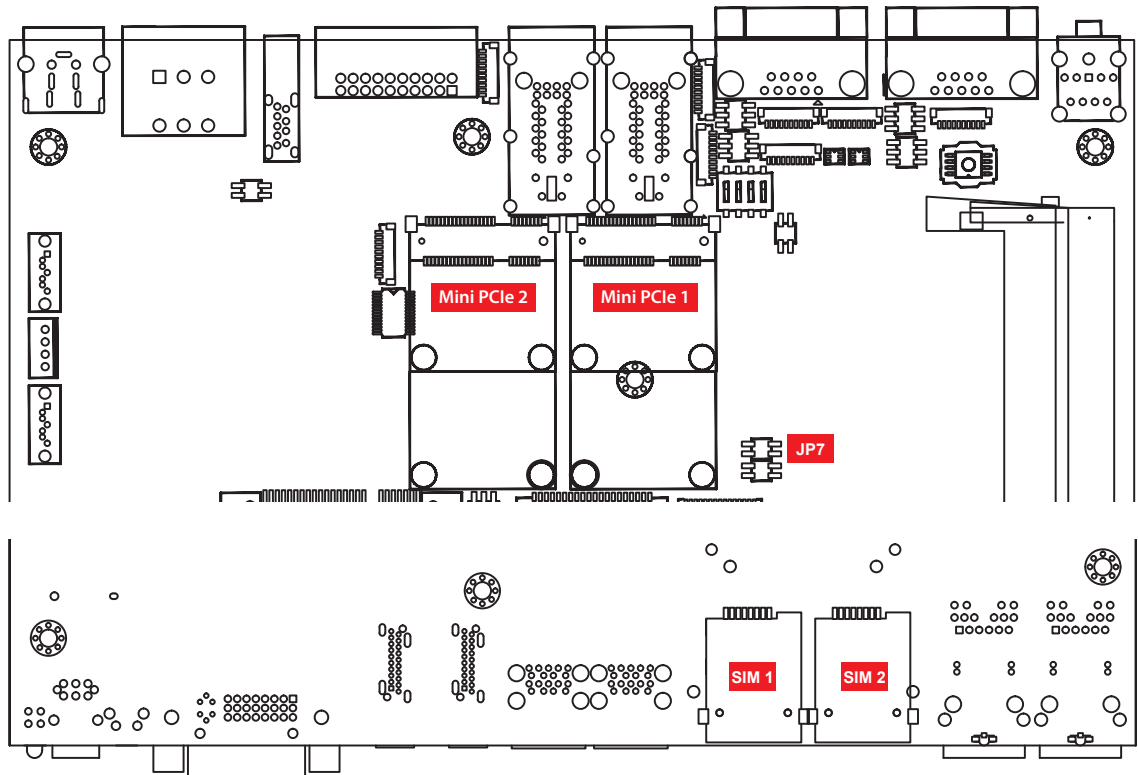

## 2.2.9 PD (Powered Device) Ethernet Port

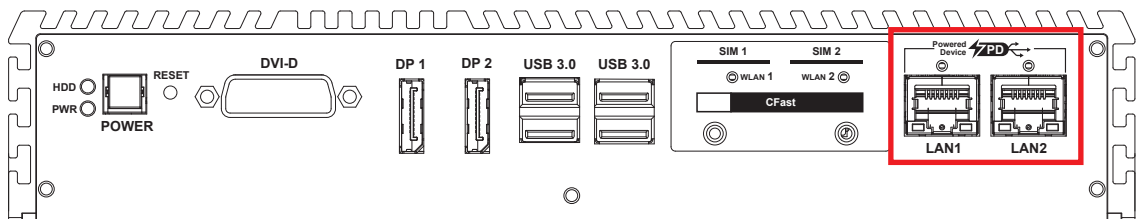

There are 2 PD (Powered Device) 8-pin RJ-45 jacks supporting 10/100/1000 Mbps Ethernet connections with PD in the front side of ECS-4500. LAN 1 is powered by Intel® 219LM Ethernet engine and LAN 2 is powered by Intel® I210. When both LAN 1 and LAN 2 work in normal status, basic iAMT function is enabled. Each PD port can be supported at 25.5W for ECS-4500 used by other external PoE<sup>+</sup>/PoE<sup>+</sup> Hub.

Using suitable RJ-45 cable, you can connect ECS-4500 system to a computer or to any other devices with Ethernet connection; for example, a hub or a switch. Moreover, both of LAN 1 and LAN 2 support Wake on LAN and Pre-boot functions. The pinouts of LAN 1 and LAN 2 are listed as follows:

Pin No.	10/100Mbps	1000Mbps
1	E_TX+	MDIO_P
2	E_TX-	MDIO_N

3	E_RX+	MDI1_P
4	----	MDI2_P
5	----	MDI2_N
6	E_RX-	MDI1_N
7	----	MDI3_P
8	-----	MDI3_N

Each LAN port is supported by standard RJ-45 connector with LED indicators to present Active/Link/Speed status of the connection. The LED indicator on the left bottom corner lightens in solid green when the cable is properly connected to a 100 Mbps Ethernet network, and it lightens in solid orange when the cable is properly connected to a 1000 Mbps Ethernet network. The right LED will keep twinkling/off when Ethernet data packets are being transmitted or received.

Bottom Led	10Mbps	100Mbps	1000Mbps
Left	Off	Solid Green	Solid Orange
Right	Flash Yellow	Flash Yellow	Flash Yellow

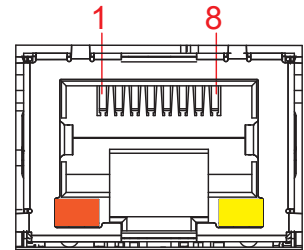

PD LED indicators as below :

Please note to keep enough power when ECS-4500 is working in high performance.

Location	LED Color	Status
LAN1	Green	Green : POE installed & power in Off : Non-PoE
LAN2	Green	Green : PD installed & power in Off : Non-PoE

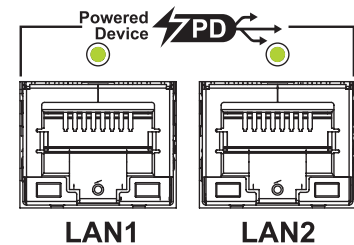

## 2.2.10 SSD/HDD Tray

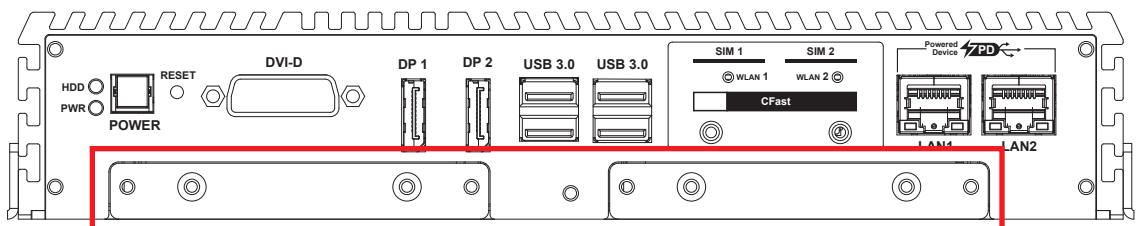

There are 2 front-access 2.5"SSD/ HDD trays in the front side of ECS-4500. Just trigger to open the SSD/HDD tray, up to 4TB is available.

## 2.3 Rear Panel I/O and Functions

### 2.3.1 Power Terminal Block

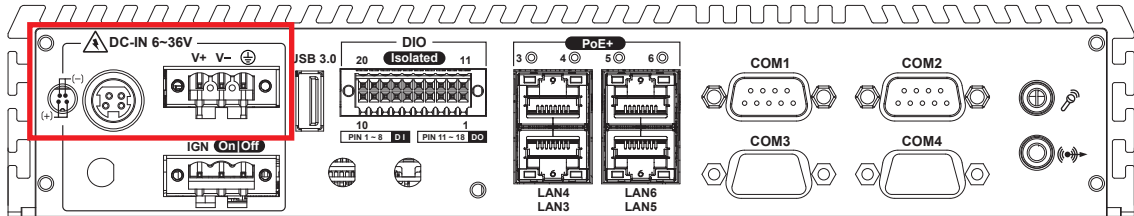

ECS-4500 supports 6V to 36V DC power input by terminal block in the rear side. In normal power operation, power LED lightens in solid green. Onboard LTC4356 supports up to 80V surge protection.

Pin No.	Definition	Pin No.	Definition
1	V+	2	V-
3	Chassis Ground		

### 2.3.2 Remote Power On/Off Switch & Ignition

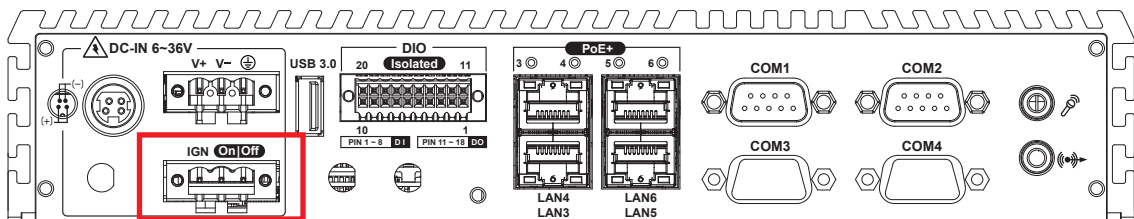

It is a 2-pin power-on or power-off switch through Phoenix Contact terminal block. You could turn on or off the system power by using this contact. This terminal block supports dual function of soft power-on/ power-off (instant off or delay 4 second), and suspending mode.

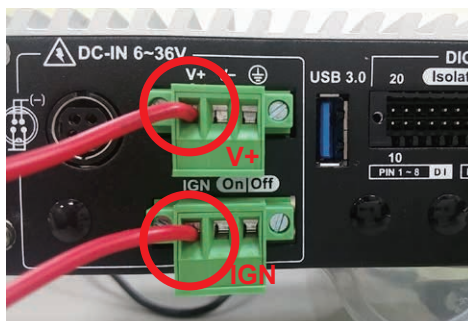

Pin No.	Definition
1	Ignition (IGN)
2	External Power S/W +
3	External Power S/W -

### 2.3.3 Isolated DIO

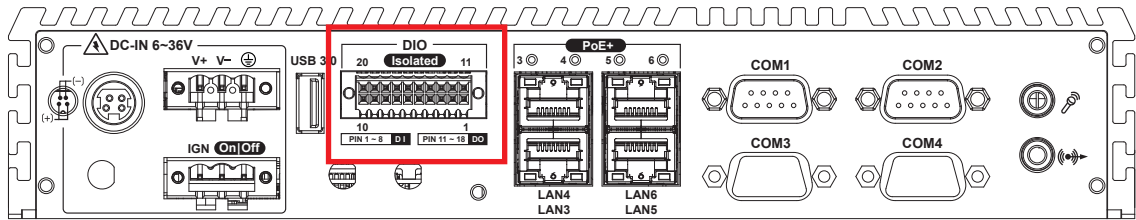

There is a 16-bit DIO (8-bit DI, 8-bit DO) connector in the rear side. Each DIO channel is equipped with a photocoupler for isolated protection. A power buffer device TPD2007F integrated in 8-DO circuit for motors, solenoids, and lamp driver applications. Please refer to Appendix A for more details.

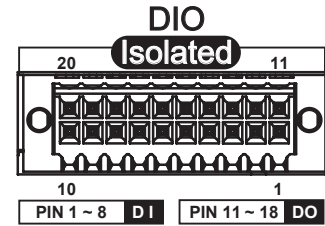

DIO Connectors pin out:

DIO	Pin No.	Definition	Function
DIO	1	INPUT 0	SIO_GPI80
	2	INPUT 1	SIO_GPI81
	3	INPUT 2	SIO_GPI82
	4	INPUT 3	SIO_GPI83
	5	INPUT 4	SIO_GPI84
	6	INPUT 5	SIO_GPI85
	7	INPUT 6	SIO_GPI86
	8	INPUT 7	SIO_GPI87
	9	DI1_COM	-
	10	DIO1_GND	-
	11	OUTPUT 0	SIO_GPO70
	12	OUTPUT 1	SIO_GPO71
	13	OUTPUT 2	SIO_GPO72
	14	OUTPUT 3	SIO_GPO73
	15	OUTPUT 4	SIO_GPO74
	16	OUTPUT 5	SIO_GPO75
	17	OUTPUT 6	SIO_GPO76
	18	OUTPUT 7	SIO_GPO77
	19	DIO1_GND	-
	20	DIO1_VDC (6~48V Input)	-



DI reference circuit:

Sink Mode (NPN)

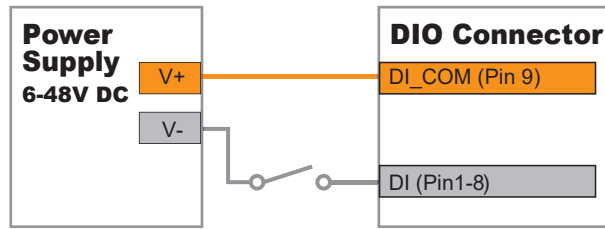

Source Mode (PNP)

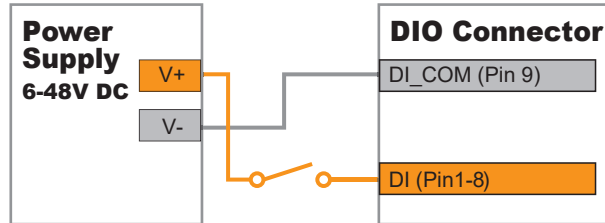

DO reference circuit:

Sink Mode  
(NPN, Default)

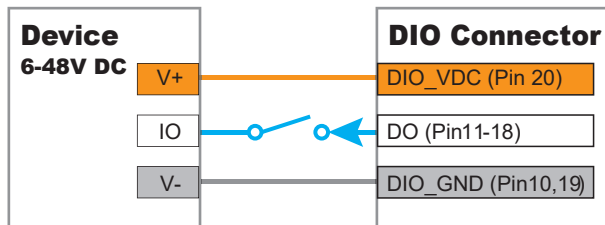

Source Mode (PNP)

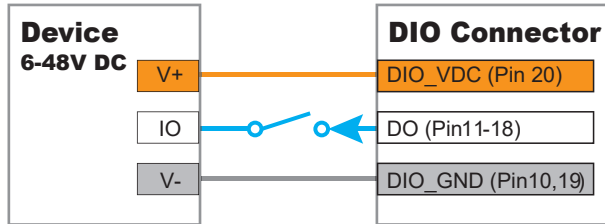

## 2.3.4 Serial Port

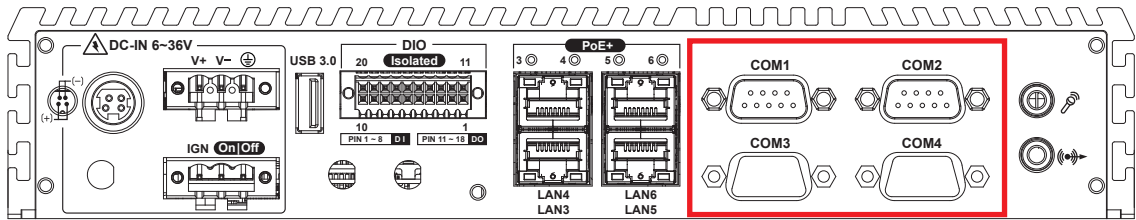

Serial port 1 to 4 (COM 1 to 4) can be configured for RS-232, RS-422, or RS-485 with auto flow control communication. The default definition is RS-232. If you want to change to RS-422 or RS-485, you can find the setting in BIOS.

BIOS Setting	Function
COM 1 (CN1) COM 2 (CN2) COM3 (JCOM3) COM4 (JCOM4)	RS-232
	RS-422 (5-wire)
	RS-422 (9-wire)
	RS-485
	RS-485 w/z auto-flow control

The pin assignments are listed in the table as follow :

Serial Port	Pin No.	RS-232	RS-422 (5-wire)	RS-422 (9-wire)	RS-485 (3-wire)
1 to 4	1	DCD	TXD-	TXD-	DATA-
	2	RXD	TXD+	TXD+	DATA+
	3	TXD	RXD+	RXD+	-----
	4	DTR	RXD-	RXD-	-----
	5	GND	GND	GND	GND
	6	DSR	-----	RTS-	-----
	7	RTS	-----	RTS+	-----
	8	CTS	-----	CTS+	-----
	9	RI	-----	CTS-	-----

### 2.3.5 PoE (Power over Ethernet) Ports

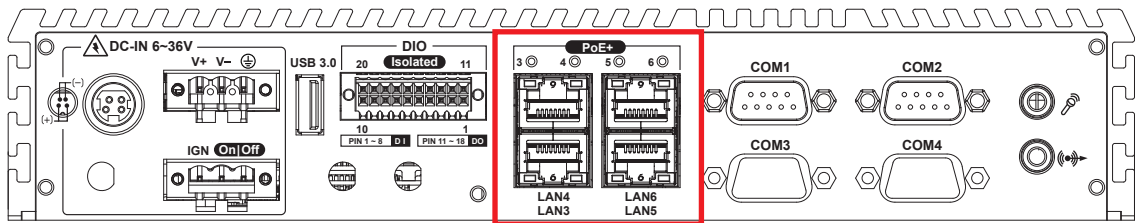

There are 4-port 8-pin PoE<sup>+</sup> (Power over Ethernet) RJ-45 jacks supporting 10/100/1000 Mbps Ethernet connections in the rear side and powered by Intel I210 Ethernet engine. When both LAN 1 and LAN 2 work in normal status, iAMT 11.0 function is enabled. (Each PoE support 30.4W/ 54V)

When using suitable RJ-45 cable, you can connect the system to a computer, or to any other devices with Ethernet connection; for example, a hub or a switch. Moreover, all of LAN3, LAN4, LAN5 and LAN6 support Wake on LAN and Pre-boot functions. The pin-outs of LAN3, LAN4, LAN5 and LAN6 are listed as follows:

Pin No.	10/ 100 Mbps	1000 Mbps	PoE
1	E_TX+	MDI0_P	PoE+
2	E_TX-	MDI0_N	PoE+
3	E_RX+	MDI1_P	PoE-
4	----	MDI2_P	----
5	-----	MDI2_N	----
6	E_RX-	MDI1_N	PoE-
7	-----	MDI3_P	----
8	-----	MDI3_N	----

Each LAN port is supported by standard RJ-45 connector with LED indicators to present Active/Link/Speed status of the connection & POE status LED.

The LED indicator on the right bottom corner lightens in solid green when the cable is properly connected to a 100 Mbps Ethernet network, and it lightens in solid orange when the cable is properly connected to a 1000 Mbps Ethernet network. The left LED will keep twinkling/ off when Ethernet data packets are being transmitted/received.

LED Status	10Mbps	100Mbps	1000Mbps
Right Bottom Led	Off	Solid Green	Solid Orange
Left Bottom Led	Flash Yellow	Flash Yellow	Flash Yellow

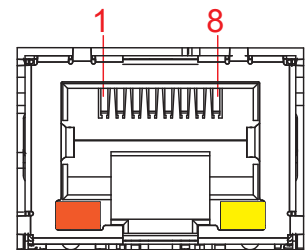

PoE LED indicator:  
Strongly suggest to use PoE function when power input is over 11V.



LED Location	LED Color	Status
LAN3	Green	Green Light: PD installed & powered green Off: Non PD
LAN4	Green	Green Light: PD installed & powered green Off: Non PD
LAN5	Green	Green Light: PD installed & powered green Off: Non PD
LAN6	Green	Green Light: PD installed & powered green Off: Non PD

### 2.3.6 Audio Jack

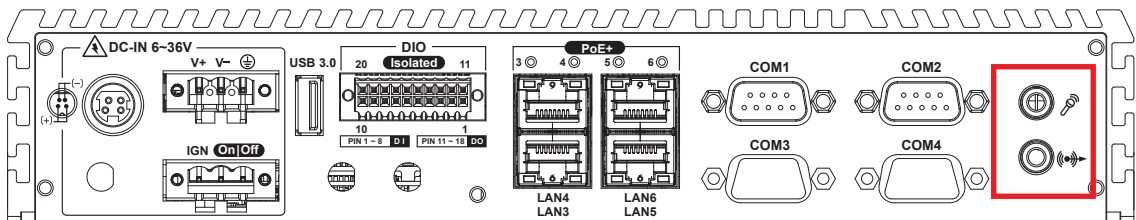

There are 2 audio connectors, Mic-in and Line-out, in the rear side of ECS-4500. Onboard Realtek ALC888S-VD audio codec supports 7.1 channel HD audio and fully complies with Intel® High Definition Audio (Azalia) specifications.

To utilize the audio function in Windows platform, you need to install corresponding drivers for both Intel CM236 chipset and Realtek ALC888S-VD codec.

### 2.3.7 USB3.0

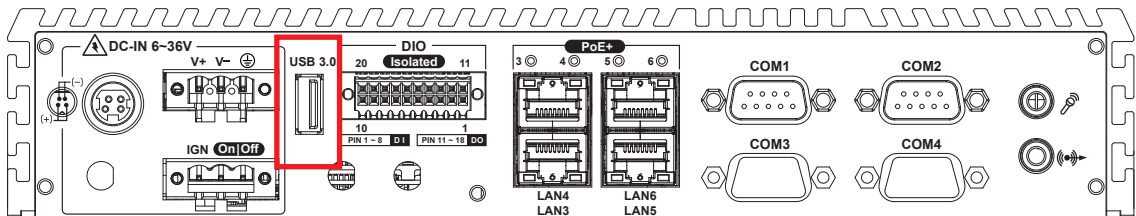

There are 5 USB 3.0 (4 on the front, 1 on the rear panel) connections available supporting up to 5GB per second data rate in the front/rear side of ECS-4500. It is also compliant with the requirements of Super Speed (SS), High Speed (HS), Full Speed (FS) and Low Speed (LS).

## 2.4 Main Board Expansion Connectors

### 2.4.1 Top View of ECS-4500 Main Board With Connector Location

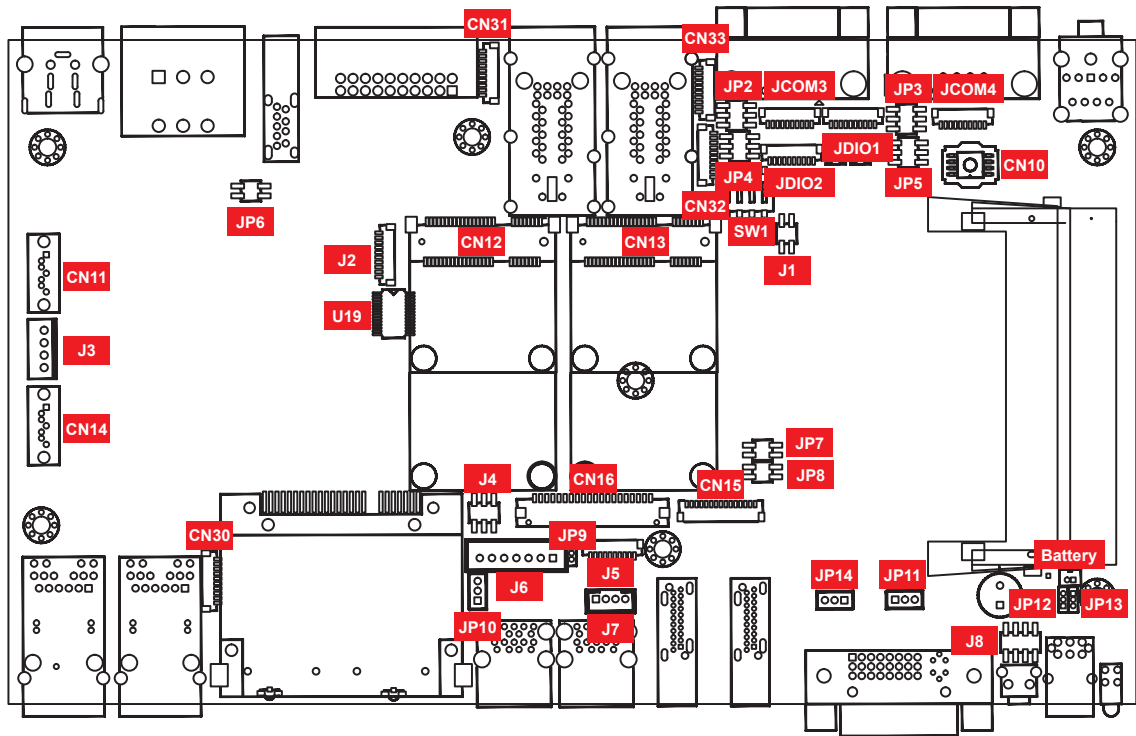

### 2.4.2 Bottom View of ECS-4500 Main Board with Connector Location

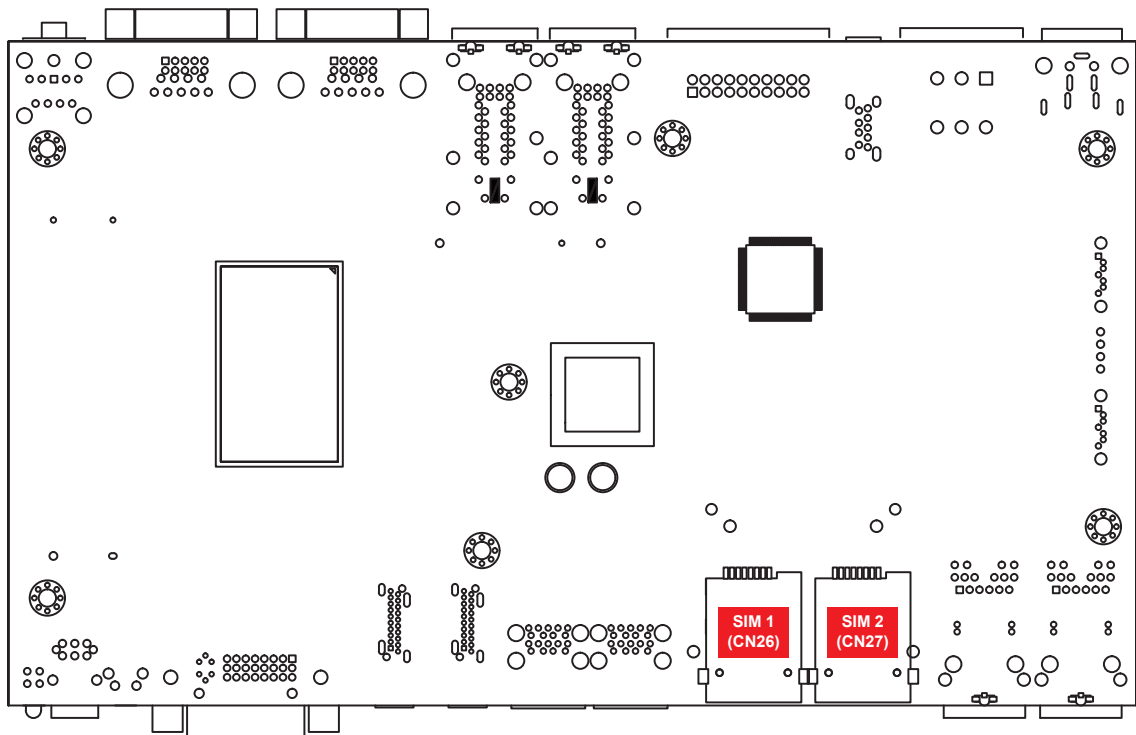

### 2.4.3 Miscellaneous Pin Header

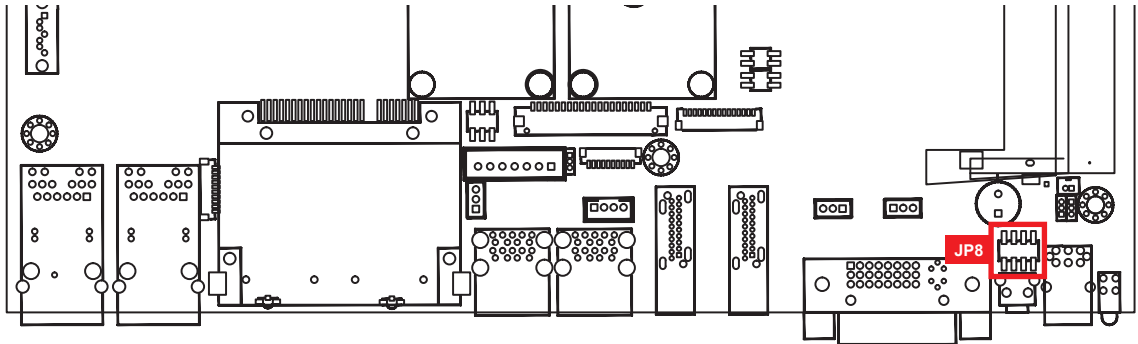

This pin header can be used as a backup for following functions, such as hard drive LED indicator, reset button, power LED indicator, and power-on/off button, which already can be accessed by front panel and top panel. The pin-outs of Miscellaneous port are listed in following table:

Group	Pin No.	Description
HDD LED	1	HDD_LED_P
	3	HDD_LED_N
RESET BUTTON	5	FP_RST_BTN_N
	7	Ground
POWER LED	2	PWR_LED_P
	4	PWR_LED_N
POWER BUTTON	6	FP_PWR_BTN_P
	8	Ground

### 2.4.4 LVDS

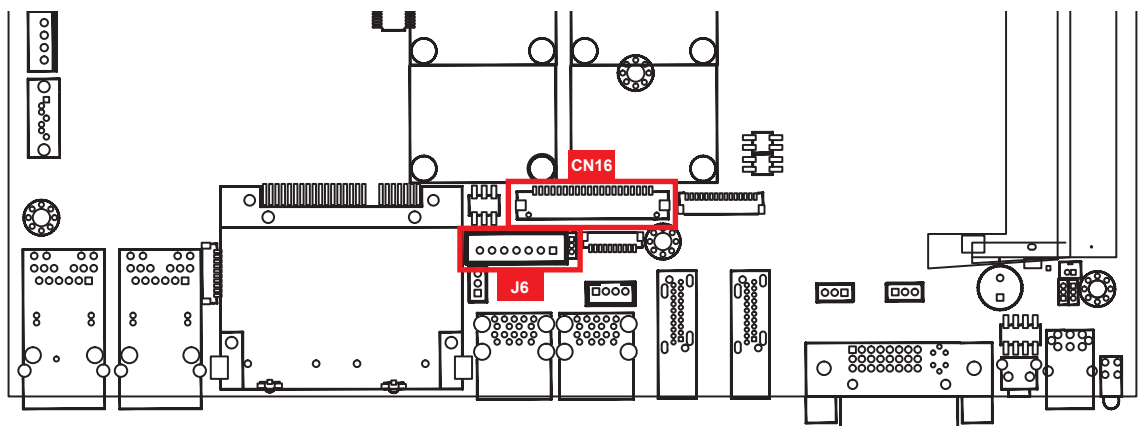

ECS-4500 supports dual-channel 24-bit LVDS display, up to 1920 x 1200 pixels resolution. The pin assignments of CN16 are listed in the following table:

Pin No.	Definition	Pin No.	Definition
1	PANEL_VDD	21	GND
2	TXO0-	22	TXE0-
3	PANEL_VDD	23	GND
4	TXO0+	24	TXE0+
5	PANEL_VDD	25	GND
6	TXO1-	26	TXE1-
7	GND	27	GND
8	TXO1+	28	TXE1+
9	GND	29	GND
10	TXO2-	30	TXE2-
11	GND	31	GND
12	TXO2+	32	TXE2+
13	GND	33	GND
14	TXOC-	34	TXEC-
15	GND	35	GND
16	TXOC+	36	TXEC+
17	GND	37	GND
18	TXO3-	38	TXE3-
19	GND	39	LVDS_DET#
20	TXO3+	40	TXE3+

The LCD inverter is connected to J6 via a JST 7-pin, 2.5mm connector providing +5V/ +12V power to LCD display. The pin assignments are listed in the following table:

Pin No.	Definition	Pin No.	Definition
1	+5V	5	GND
2	+12V	6	GND
3	+12V	7	LBKLT_EN
4	LBKLT_CTL		

## 2.4.5 SATA III Connector

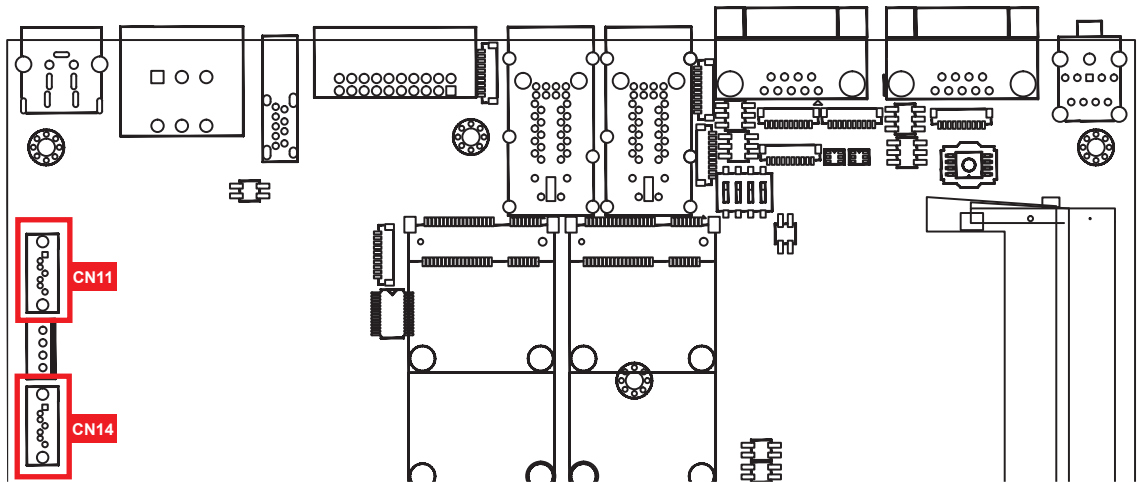

There are 2 onboard high performance Serial ATA III (SATA III) on ECS-4500. It supports higher storage capacity with less cabling effort and smaller required space. The pin assignments of CN11 and CN14 are listed in the following table:

Pin No.	Definition	Pin No.	Definition
1	GND	5	RXN
2	TXP	6	RXP
3	TXN	7	GND
4	GND		

## 2.4.6 SATA Power Header

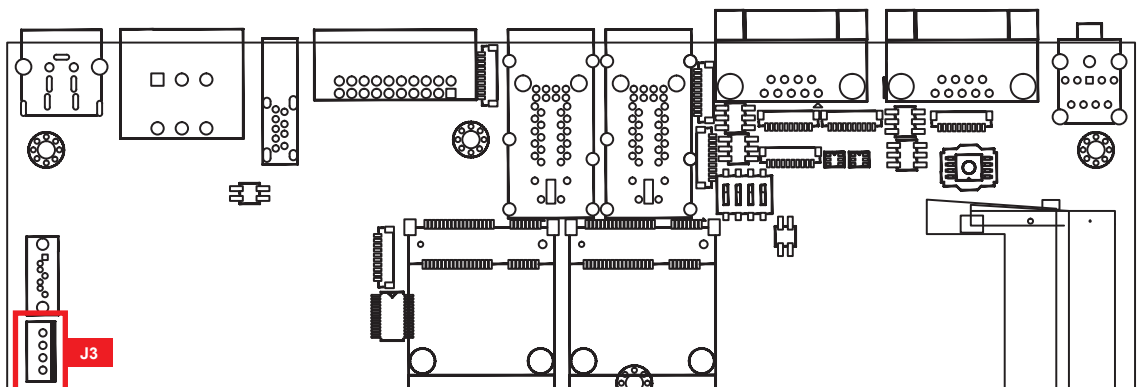

The ECS-4500 is also equipped with 1 SATA power connector. It supports 5V (Up to 2A) and 12V (Up to 1A) current to the hard drive or SSD. The pin assignments of J3 is listed in the following table:

Pin No.	Definition	Pin No.	Definition
1	+12V	3	GND
2	GND	4	+5V



## 2.4.7 Internal USB2.0

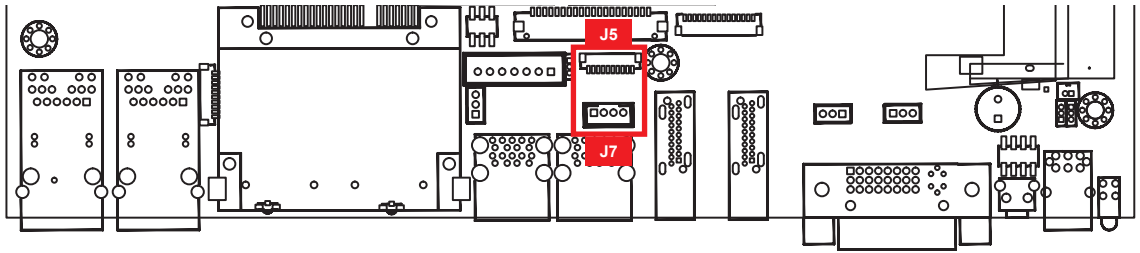

The ECS-4500 main board provides 3 expansion USB ports using plug-and-play for Dongle Key or LCD touch Panel. The USB interface supports 480 Mbps transfer rate complied with high speed USB specification Rev. 2.0.

The USB interface is accessed through one 4-pin JST 2.0mm connector and one 10-pin JST 1.0mm connector. You will need an adapter cable if you use a standard USB connector. The pin assignments of J5, J7 are listed in the following table:

Connector	Pin No.	Description	Pin No.	Description
J7	1	USB_VCC	3	USBD+
	2	USBD-	4	GND

Connector	Pin No.	Description	Pin No.	Description
J5	1	USB_VCC	6	USB2D-
	2	USB_VCC	7	USB2D+
	3	USB_VCC	8	GND
	4	USB1D-	9	GND
	5	USB1D+	10	GND

## 2.4.8 Mini PCIe/mSATA Slot

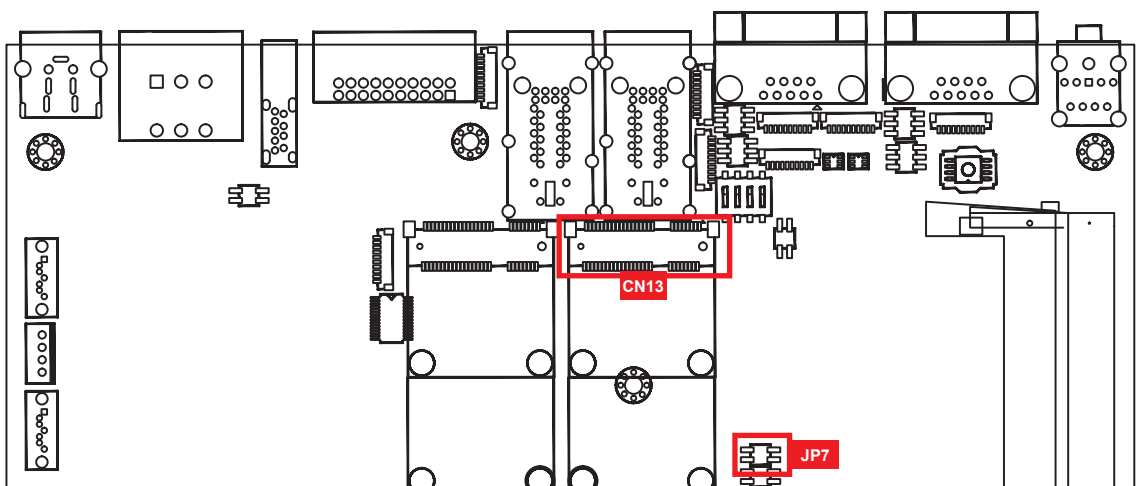

Both mSATA and Mini PCIe share the same form factor and similar electrical pinout assignments on their connectors. There was no clear mechanism to distinguish if a mSATA drive or a Mini PCIe device is plugged into the socket until recently that SATA I/O issued an ECN change (ECN #045) to redefine pin-43 on mSATA connector as “no connect” instead of “return current path” (or GND).

When an mSATA drive is inserted, its pin-43 is “no connect”, and the respective pin on the socket is being pulled-up to logic 1. When a Mini PCIe device is inserted, its pin-43 forces the respective pin on the socket to ground, or logic 0.

ECS-4500 using JP7 Pin-43 status designed for switching between mSATA drive and Mini PCIe device.

Header	Interface	Header	Interface
1-2	Auto Detection	1-3	mSATA
2-4	Mini PCIe		

The pin assignments of CN13 are listed in the following table:

Pin No.	Function	Pin No.	Function
51	Reserved	52	+V3P3aux
49	Reserved	50	GND
47	Reserved	48	+1.5V
45	Reserved	46	Reserved
43	Status	44	Reserved
41	+V3P3aux	42	Reserved
39	+V3P3aux	40	GND
37	GND	38	USB_D+
35	GND	36	USB_D-
33	PETp0	34	GND
31	PETn0	32	SMB_DATA
29	GND	30	SMB_CLK
27	GND	28	+1.5V
25	PERp0	26	GND
23	PERn0	24	+V3P3aux
21	GND	22	PERST#

19	Reserved	20	reserved
17	Reserved	18	GND
Mechanical Key			
15	GND	16	UIM_VPP
13	REFCLK+	14	UIM_RESET
11	REFCLK-	12	UIM_CLK
9	GND	10	UIM_DATA
7	CLKREQ#	8	UIM_PWR
5	Reserved	6	1.5V
3	Reserved	4	GND
1	WAKE#	2	3.3Vaux

## 2.4.9 Mini PCIe

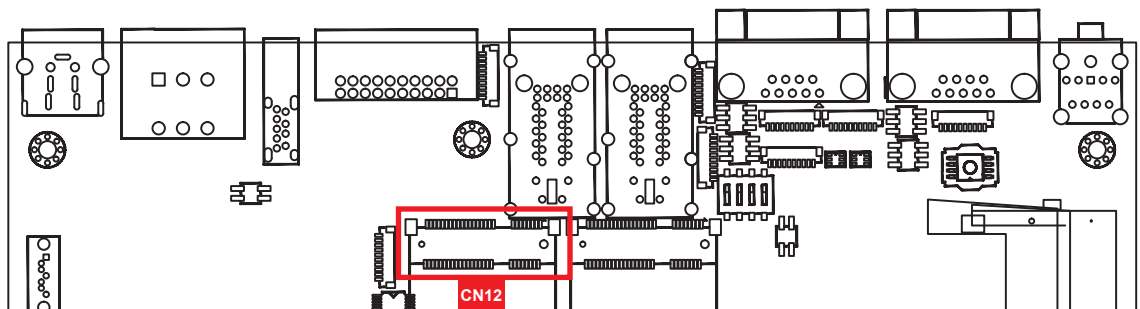

The pin assignments of CN12 are listed in the following table:

Pin No.	Function	Pin No.	Function
51	Reserved	52	+V3P3aux
49	Reserved	50	GND
47	Reserved	48	+1.5V
45	Reserved	46	Reserved
43	GND	44	Reserved
41	+V3P3aux	42	Reserved
39	+V3P3aux	40	GND
37	GND	38	USB_D+
35	GND	36	USB_D-

33	PETp0	34	GND
31	PETn0	32	SMB_DATA
29	GND	30	SMB_CLK
27	GND	28	+1.5V
25	PERp0	26	GND
23	PERn0	24	+V3P3aux
21	GND	22	PERST#
19	Reserved	20	reserved
17	Reserved	18	GND
Mechanical Key			
15	GND	16	UIM_VPP
13	REFCLK+	14	UIM_RESET
11	REFCLK-	12	UIM_CLK
9	GND	10	UIM_DATA
7	CLKREQ#	8	UIM_PWR
5	Reserved	6	1.5V
3	Reserved	4	GND
1	WAKE#	2	3.3Vaux

## 2.4.10 Battery

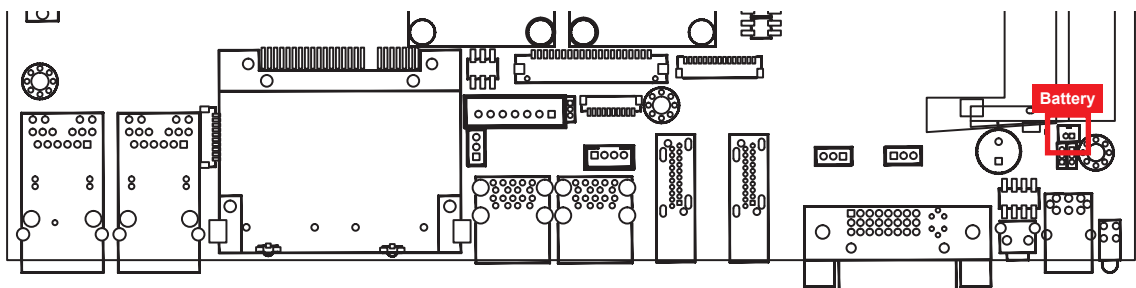

The ECS-4500 real-time clock is powered by a lithium battery. It is equipped with Panasonic BR2032 190mAh lithium battery. It is recommended that you not replace the lithium battery on your own. If the battery need to be changed, please contact the Vecow RMA service team.

### 2.4.11 LAN2 I210 SDP

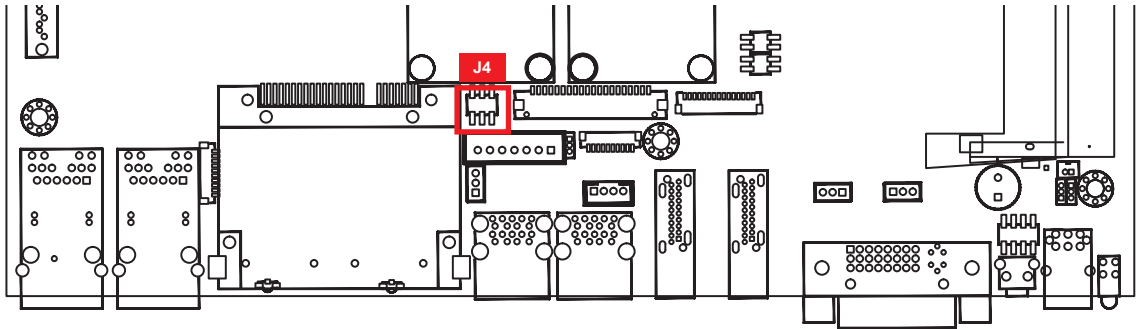

The pin assignments of J4 are listed in the following table:

Pin No.	Definition	Pin No.	Definition
1	LAN2_SDP0	4	LAN2_SDP3
2	LAN2_SDP1	5	GND
3	LAN2_SDP2	6	GND

### 2.4.12 Internal GPIO

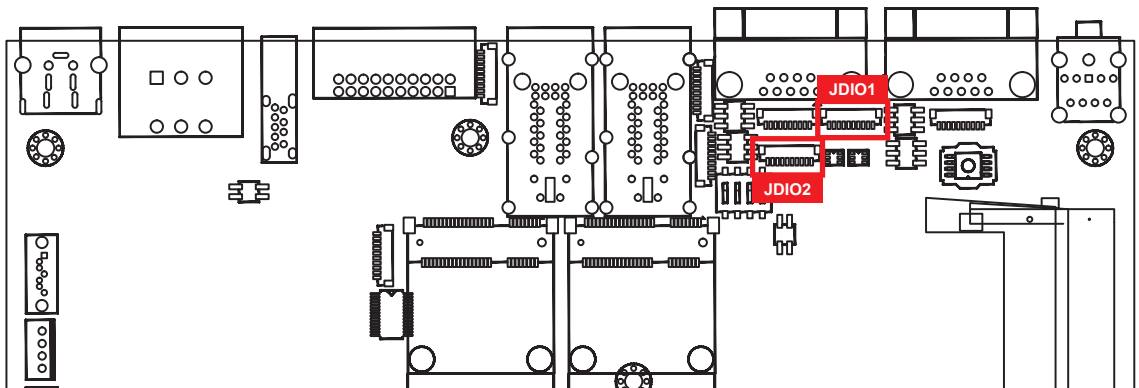

There is a 16-bit GPIO connector in the top side. Each GPIO channel can be configured by either GPI or GPO. JDIO1 and JDIO2 pins are defined in the following table:

Pin No.	JDIO1 Definition	JDIO2 Definition
1	SIO_GP11	SIO_GP37
2	SIO_GP12	SIO_GP50
3	SIO_GP15	SIO_GP51
4	SIO_GP16	SIO_GP52
5	SIO_GP32	SIO_GP56
6	SIO_GP33	SIO_GP57

7	SIO_GP35	SIO_GP64
8	SIO_GP36	SIO_GP65
9	+V5	+V5
10	GND	GND

Symbol	Parameter	Condition	Min.	Typ.	Max.	Unit
$V_{OL}$	Low Output Voltage	$I_{OL} = 8 \text{ mA}$			0.4	V
$V_{IL}$	Low Input Voltage				0.8	V
$V_{IH}$	High Input Voltage		2.2			V
$I_{IL}$	Low Input Leakage	$V_{IN} = 0$			10	$\mu\text{A}$
$I_{IH}$	High Input Leakage	$V_{IN} = V_{CC3}$			-10	$\mu\text{A}$
$I_{OZ}$	3-state Leakage				20	$\mu\text{A}$

### 2.4.13 BIOS Socket

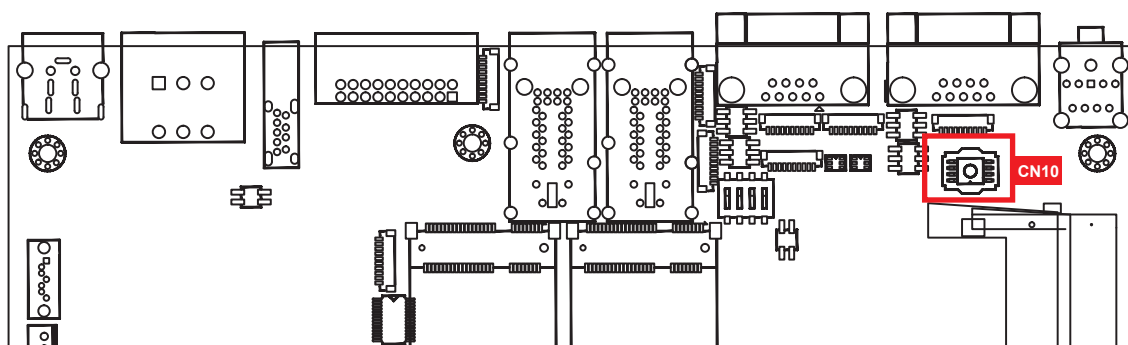

If the BIOS need to be changed, please contact the Vecow RMA service team.

### 2.4.14 LPC Port 80 Header

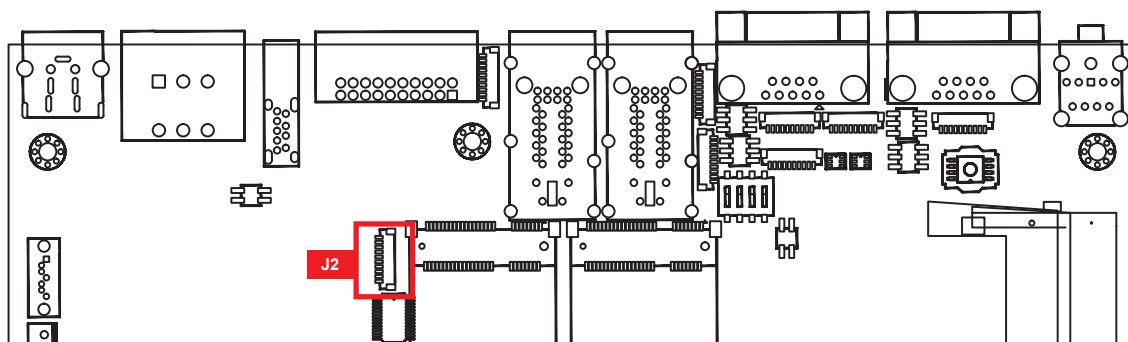

ECS-4500 provides a LPC Port 80 Header for Debug Card.

## 2.4.15 External LAN LED Header

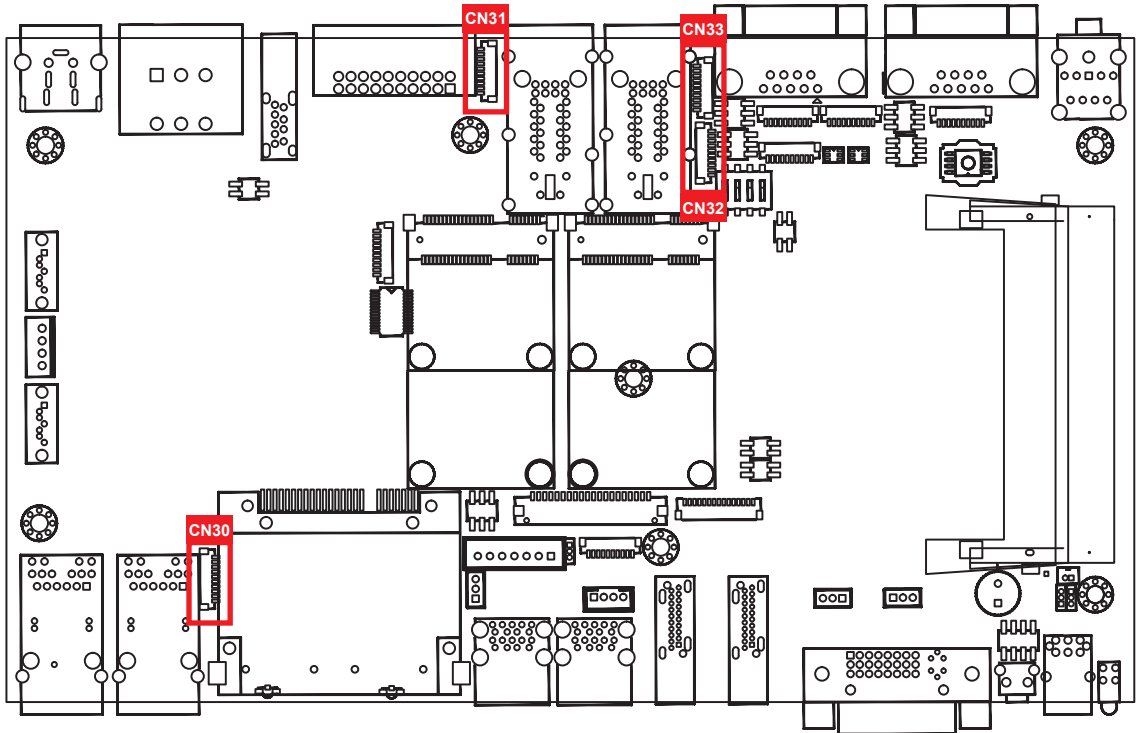

ECS-4500 provides LAN LED to indicate LAN status, PoE power on/off and PD power on/off for external chassis use.

Header	Pin No.	Function	Pin No.	Function
CN30	1	LAN1_LINK100#	6	LAN2_LINK100#
	2	LAN1_LINK1000#	7	LAN2_LINK1000#
	3	+V12_PD_LED1	8	+V3P3_
	4	LAN1_ACT#	9	LAN2_ACT#
	5	+V12_PD_LED2	10	GND

Header	Pin No.	Function	Pin No.	Function
CN31	1	LAN3_LINK100#	6	LAN4_LINK100#
	2	LAN3_LINK1000#	7	LAN4_LINK1000#
	3	+V3P3_A	8	+V3P3_A
	4	LAN3_ACT#	9	LAN4_ACT#
	5	NC	10	GND

Header	Pin No.	Function	Pin No.	Function
CN32	1	LAN5_LINK100#	6	LAN6_LINK100#
	2	LAN5_LINK1000#	7	LAN6_LINK1000#
	3	+V3P3_A	8	+V3P3_A
	4	LAN5_ACT#	9	LAN6_ACT#
	5	NC	10	GND

Header	Pin No.	Function	Pin No.	Function
CN33	1	POE_LED0	6	PWR_POE_LED2
	2	PWR_POE_LED0	7	POE_LED3
	3	POE_LED1	8	PWR_POE_LED3
	4	PWR_POE_LED1	9	NC
	5	POE_LED2	10	GND



## 2.5 Main Board Jumper & DIP Switch Settings

### 2.5.1 Top View of ECS-4500 With Jumper and DIP Switch

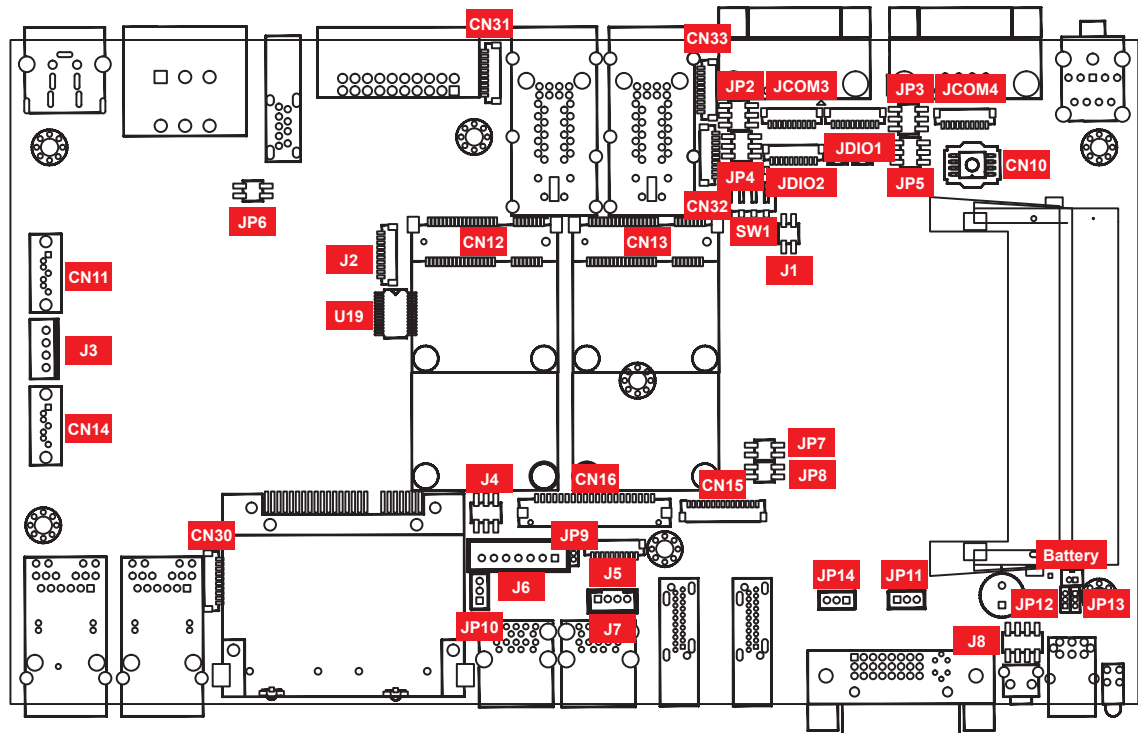

The figure below is the top view of ECS-4500 board, and it shows the location of the jumpers and the switches.

You may configure your card to match the needs of your application by setting jumpers. A jumper is a metal bridge used to close an electric circuit. It consists of two metal pins and a small metal clip (often protected by a plastic cover) that slides over the pins to connect them. To “close” a jumper, please connect the pins with the clip. To “open” a jumper, please remove the clip. Sometimes a jumper will have three pins, labeled 1, 2, and 3. In this case you would connect either pins 1 and 2, or 2 and 3.

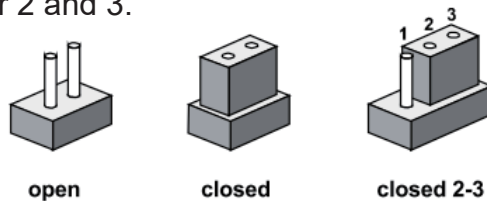

You may configure your card to match the needs of your application by DIP switch as shown below (the DIP switch on and off)

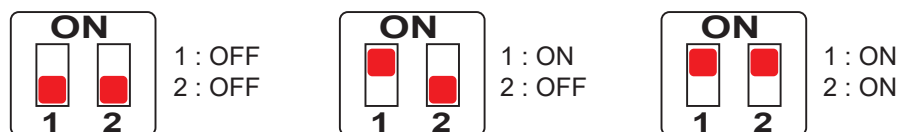

## 2.5.2 USB Power Jumper

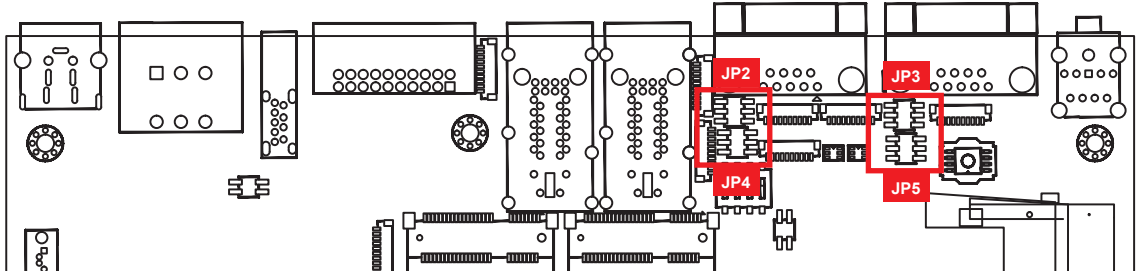

Header	Pin No.	Description
COM1 JP2	1-2	+5V (1A max.)
	3-4	+12V (0.5A max.)
	5-6	RI (Default)
COM2 JP3	1-2	+5V (1A max.)
	3-4	+12V (0.5A max.)
	5-6	RI (Default)
COM3 JP4	1-2	+5V (1A max.)
	3-4	+12V (0.5A max.)
	5-6	RI (Default)
COM4 JP5	1-2	+5V (1A max.)
	3-4	+12V (0.5A max.)
	5-6	RI (Default)

## 2.5.3 PoE Power ON Select

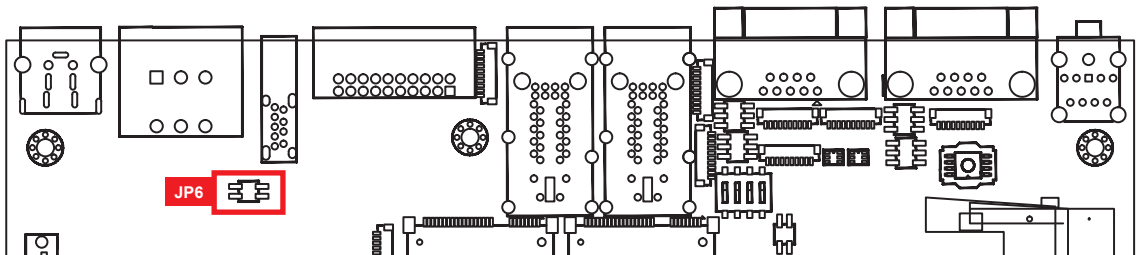

Header	Pin No.	Function
JP6	1-2	PoE power on at standby power ready
	3-4	PoE power on after system power on (Default)

## 2.5.4 CFast & mSATA Select

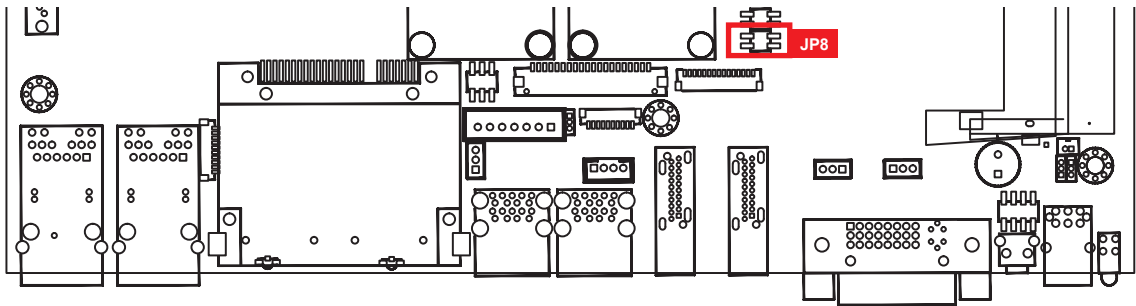

Header	Pin No.	Function
JP8	1-2	Support CFast device
	3-4	Support mSATA interface for Mini PCIe 1 (CN13)

## 2.5.5 Backlight Control Level Select

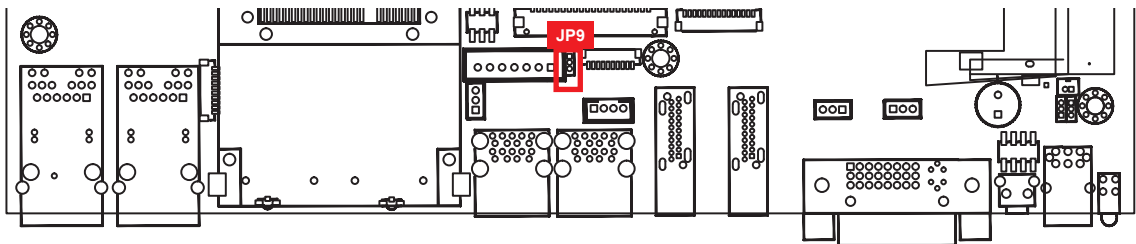

Header	Pin No.	Function
JP9	1-2	+V3P3 (Default)
	2-3	+5V

## 2.5.6 USB Power Jumper

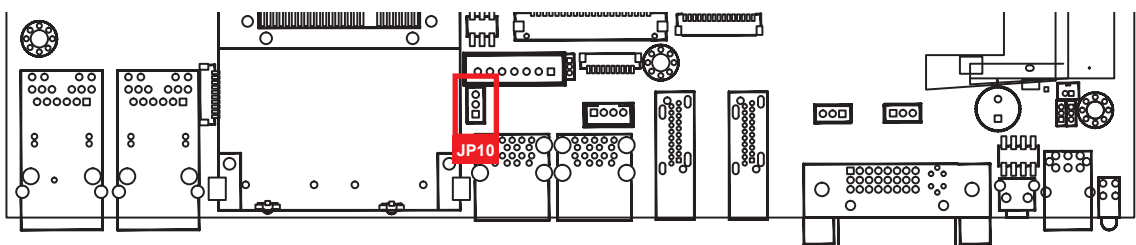

Header	Pin No.	Function
JP10	1-2	Non Wake Up support
	2-3	Supported Wake Up(Default)

### 2.5.7 LVDS Backlight Power Select

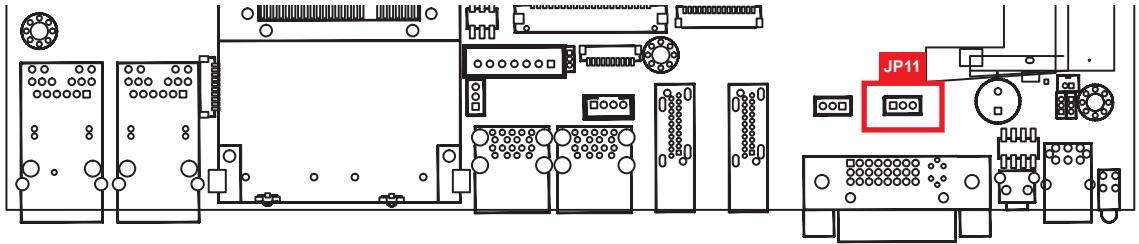

JP11 provides LVDS voltage selection function; such as closing Pin 1, 2 is for 3.3V LVDS power input and closing Pin 2, 3 is for 5V LVDS power input.

Header	Pin No.	Function
JP11	1-2	+V3P3 (Default)
	2-3	+5V

### 2.5.8 Clear ME/CMOS

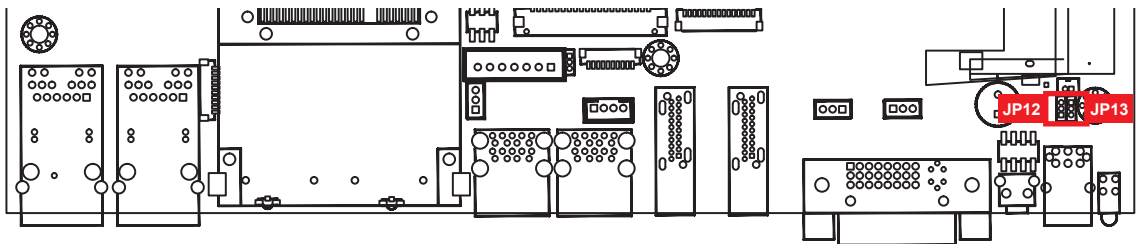

Header	Pin No.	Function
JP12 (ME)/ JP13 (CMOS)	1-2	+V3P3 (Default)
	2-3	GND

### 2.5.9 DP (DP2) & LVDS Select

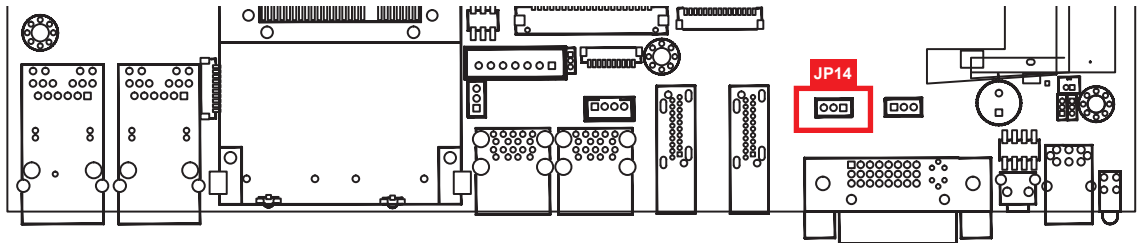

Please do note that DP2 will not be enabled when ECS-4500 supports dual-channel 24-bit LVDS display.

Header	Pin No.	Interface
JP14	1-2	DP (DP2)
	2-3	LVDS

### 2.5.10 MCU Spy-bi Wire Interface for Download FW

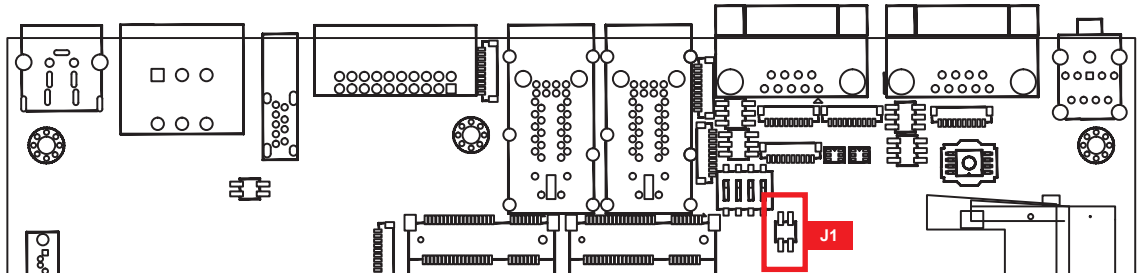

The pin assignments of J1 are listed in the following table:

Header	Pin No.	Interface
J1	1-2	DP (DP2)
	2-3	LVDS

## 2.6 Ignition Control



ECS-4500 series provides ignition power control feature for vehicle applications. The built-in MCU monitors the ignition signal and turns on/off the system according to pre-defined on/off delay periods.

### 2.6.1 Adjust Ignition Control Modes

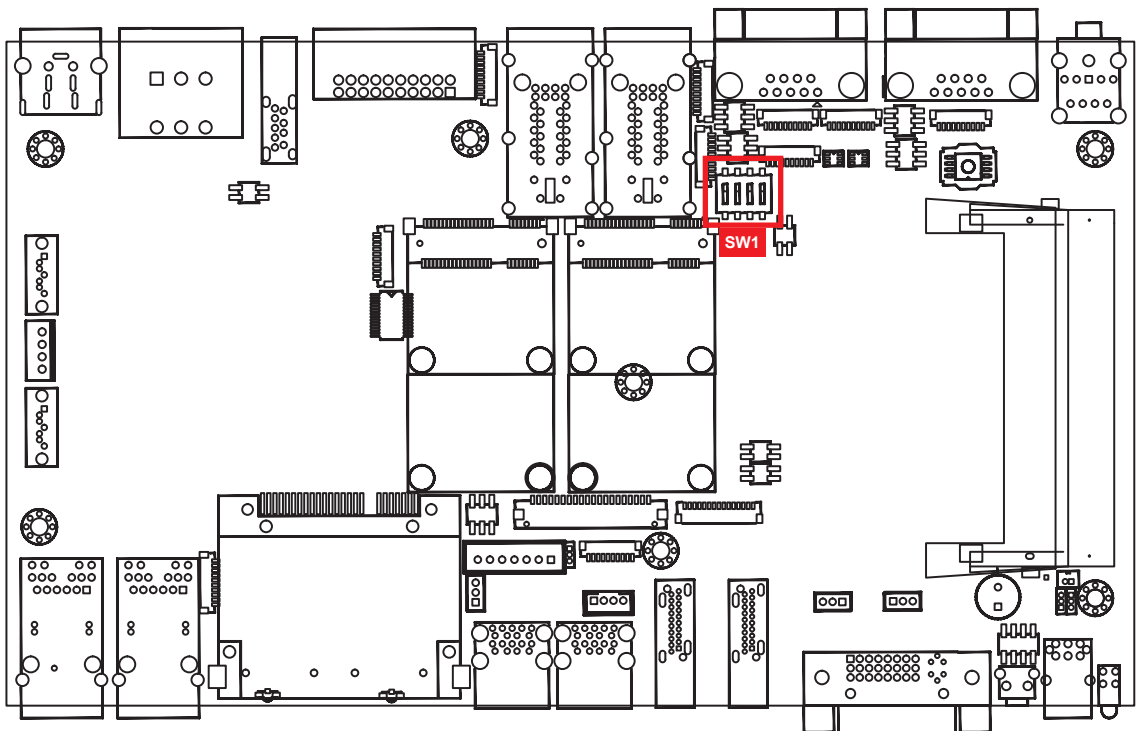
ECS-4500 series provides 16 modes of different power on/off delay periods adjustable via rotary switch. The default rotary switch is set to 0 in ATX/AT power mode.

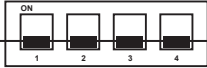
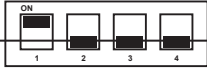
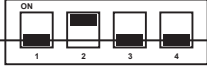
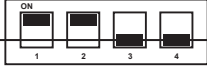
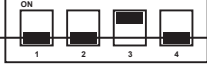
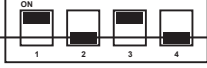
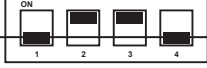
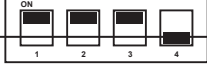
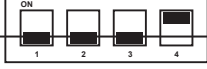
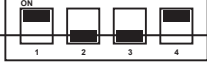
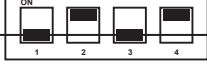

The modes are listed in the following table:

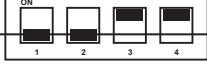
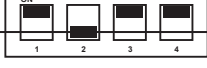
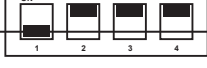
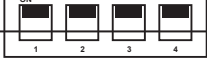
Item	Power on delay	Power off delay	Switch Position
0	ATX mode		
1	No delay	No delay	
2	No delay	5 seconds	
3	No delay	10 seconds	
4	No delay	20 seconds	
5	5 seconds	30 seconds	
6	5 seconds	60 seconds	
7	5 seconds	90 seconds	
8	5 seconds	30 minutes	
9	5 seconds	1 hour	
A	10 seconds	2 hours	
B	10 seconds	4 hours	
C	10 seconds	6 hours	
D	10 seconds	8 hours	
E	10 seconds	12 hours	
F	10 seconds	24 hours	

## 2.6.2 Ignition Control Wiring

To activate ignition control, you need to provide IGN signal via the 3-pin pluggable terminal block locates in the back panel. Please find below the general wiring configuration.

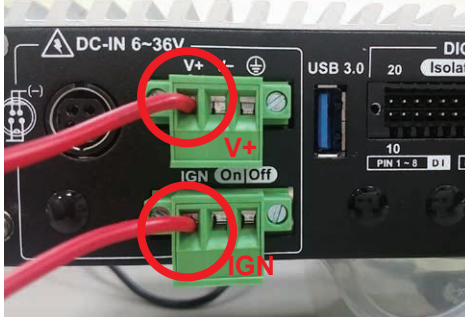

Pin No.	Definition
1	Ignition (IGN)
2	External Power S/W +
3	External Power S/W +

**V+** : Positive polarity of DC power input (Car battery+ for 12/24/36V)

**V-** : Ground of DC power input (Car battery -/GND line to GND)

**IGN** : Ignition signal input (ACC power of vehicle)

For testing purpose, you can refer to the picture blow to simulate ignition signal input controlled by a latching switch.

Note:

1. DC power source and IGN share the same ground.
2. ECS-4500 supports 6V~36V wide range DC power input in ATX/AT mode. In Ignition mode, the input voltage is fixed to 12V/24V for car battery scenario.
3. For proper ignition control, the power button setting should be "Power down" mode.

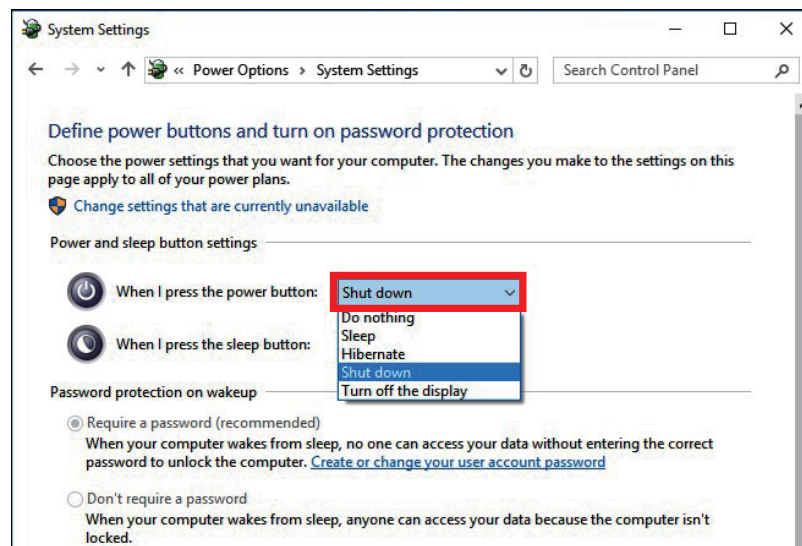

In Windows, for example, you need to set "When I press the power button" to "Shut down."

### 2.6.3 Smart Battery Protection

The system with “Ignition Control” can perform Smart Battery Protection, namely Low Battery Detection.

When the system is running on a battery and its voltage drops below the threshold, the system will automatically shut down. The Low Battery Detection is implemented in the ignition control MCU FW and as a default function.

Note:

Battery Voltage	Thresholds
12V	10.5~15V
24V	21.5~30V



# 3

## SYSTEM SETUP

### 3.1 How to Open Your ECS-4500

**Step 1** Remove four F#6-32(red) and one KHS#6-32(yellow) screws.



**Step 2** Remove one KHS#6-32 screws.



**Step 3** Take out the bottom.

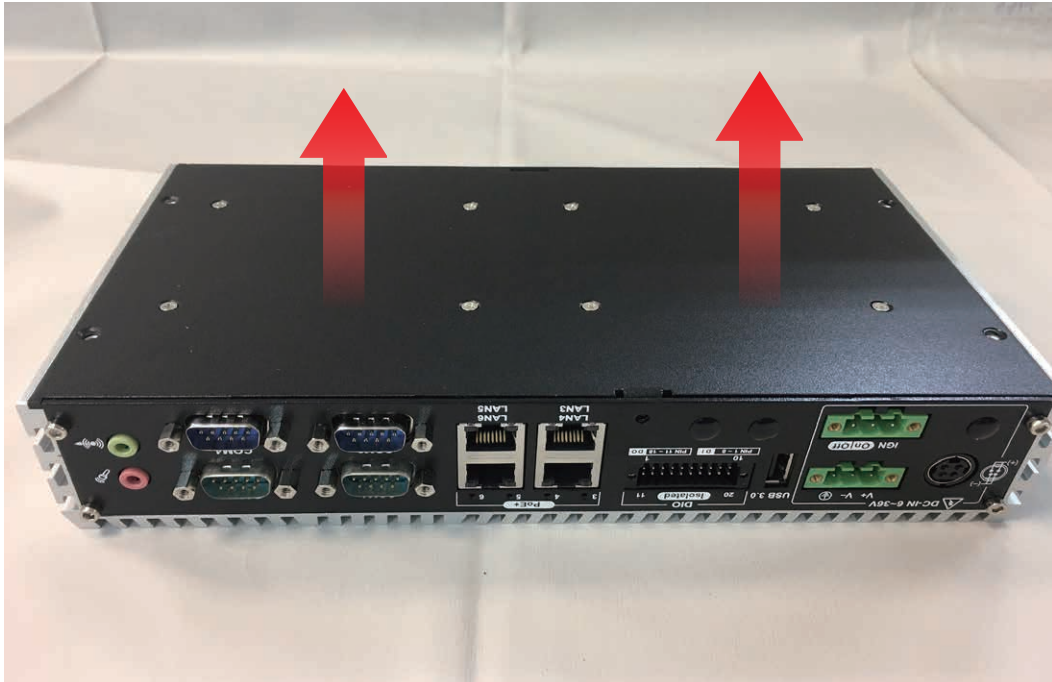

**Step 4** Finish.

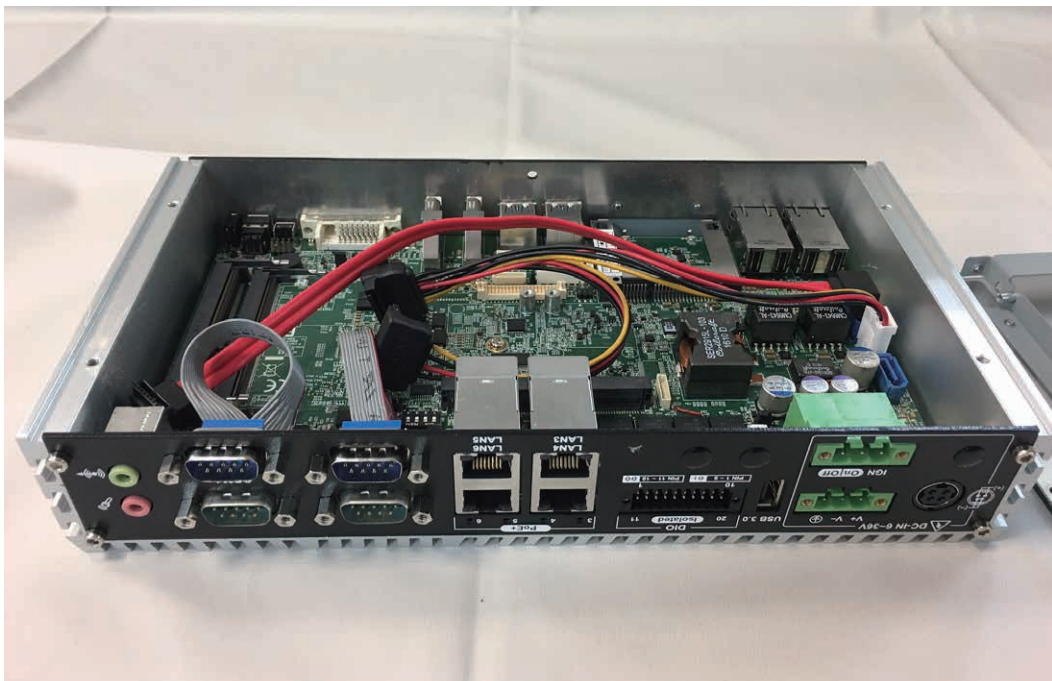

## 3.2 Installing DDR4 SO-DIMM Modules

**Step 1** Install DDR4 RAM module into SO-DIMM slot.



**Step 2** Make sure the RAM module is locked by the memory slot.

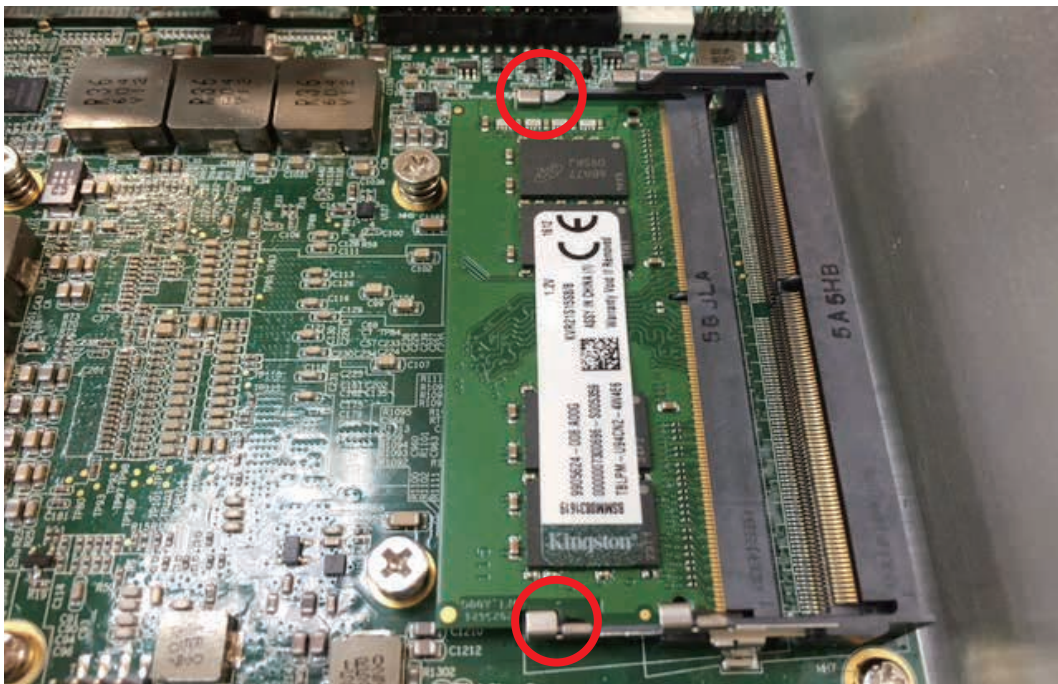

### 3.3 Installing Mini PCIe Card

**Step 1** Install Mini PCIe card into the Mini PCIe socket.



**Step 2** Fasten one M2.5 screw.



### 3.4 Installing Antenna Cable

**Step 1** Check antenna cable and washers.



**Step 2** Put Antenna cable connector into the hole on rear panel and fasten the washer 1, washer 2 and washer 3 on Antenna cable connector.



### 3.5 Installing CFast Card

**Step 1** Remove two F-M3 screws on CFast & SIM Card cover.



**Step 2** Remove CFast & SIM Card cover.

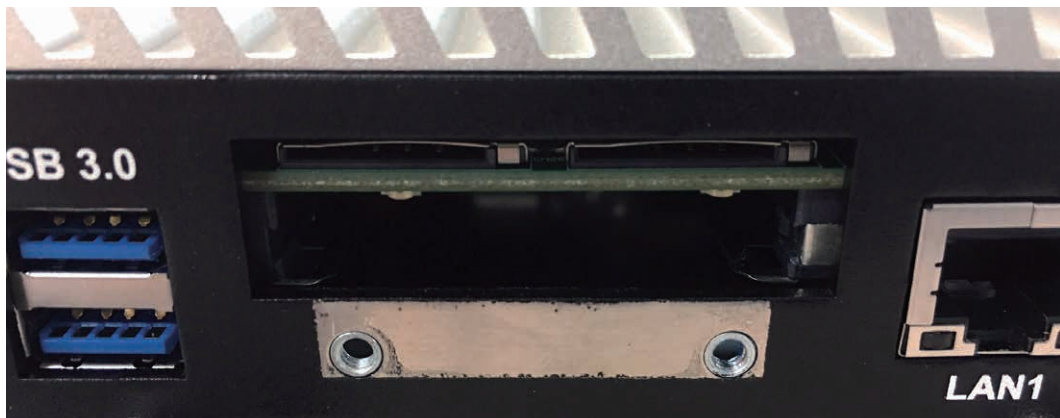

**Step 3** Before inserting CFast & SIM Card, make sure the system power is not plugged.

**Step 4** Insert CFast card and push to lock.



### 3.6 Installing SIM Card

**Step 1** Remove two F-M3 screws on CFast & SIM Card cover.

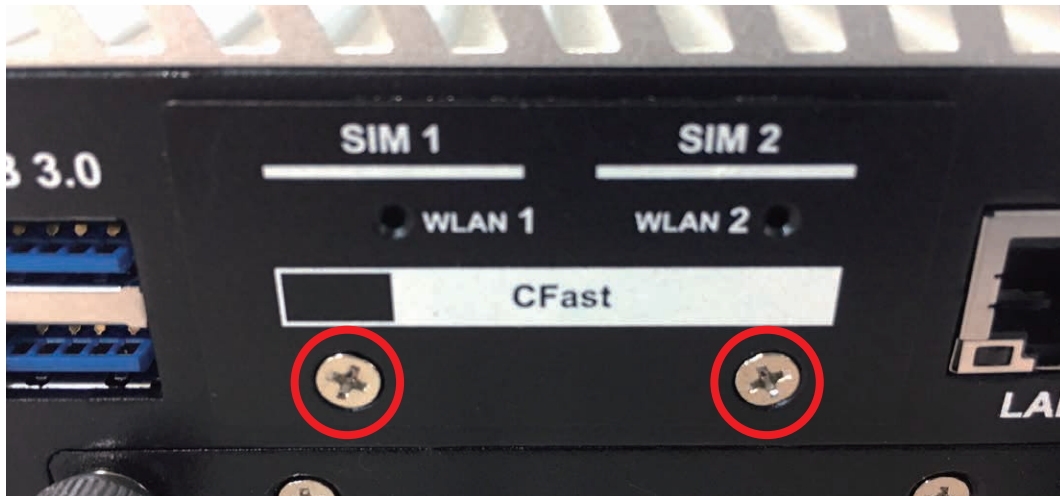

**Step 2** Remove CFast & SIM Card cover.

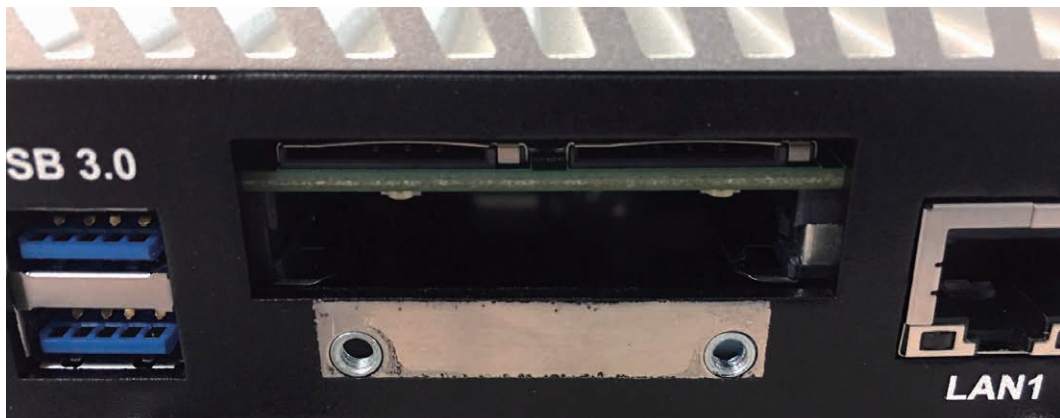

**Step 3** Before inserting CFast & SIM Card, make sure the system power is not plugged.

**Step 4** Insert SIM card and push to lock.

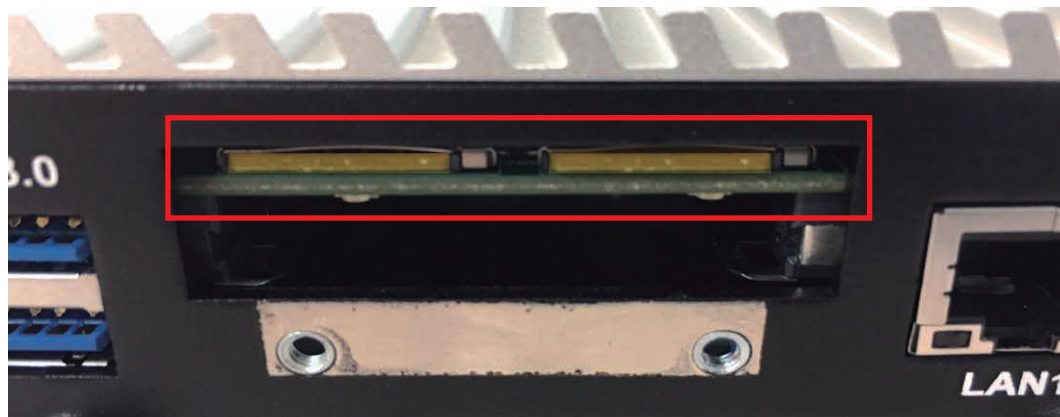

## 3.7 Installing SSD/ HDD

### 3.7.1 ECS-4500-PoER/PDR/2R series

**Step 1** SSD/HDD Tray.



**Step 2** Fix the SSD/HDD on the tray with two F-M3x4 screws.

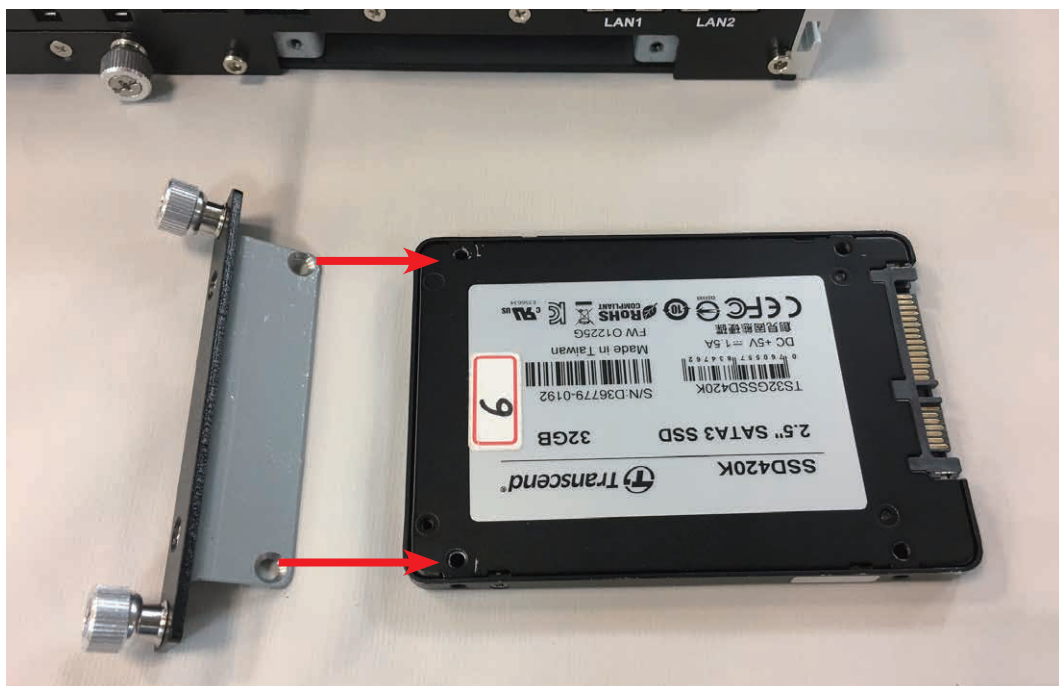



**Step 3** Fix with the tray.



**Step 4** Put the SSD/HDD tray and then clockwise fasten the locks.



### 3.7.2 ECS-4500-PoE/PD/2G series

**Step 1** Remove eight F-M3 screws.

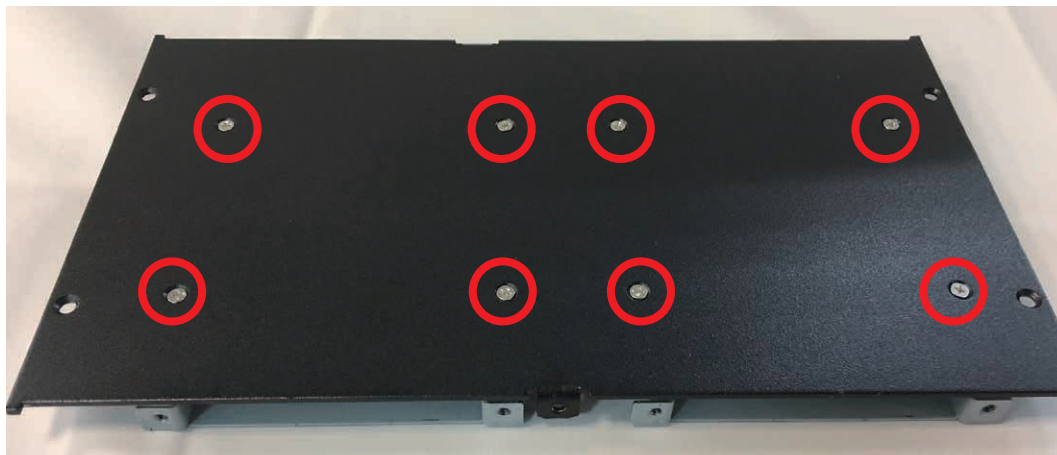

**Step 2** Install SSD/HDD with HDD bracket.

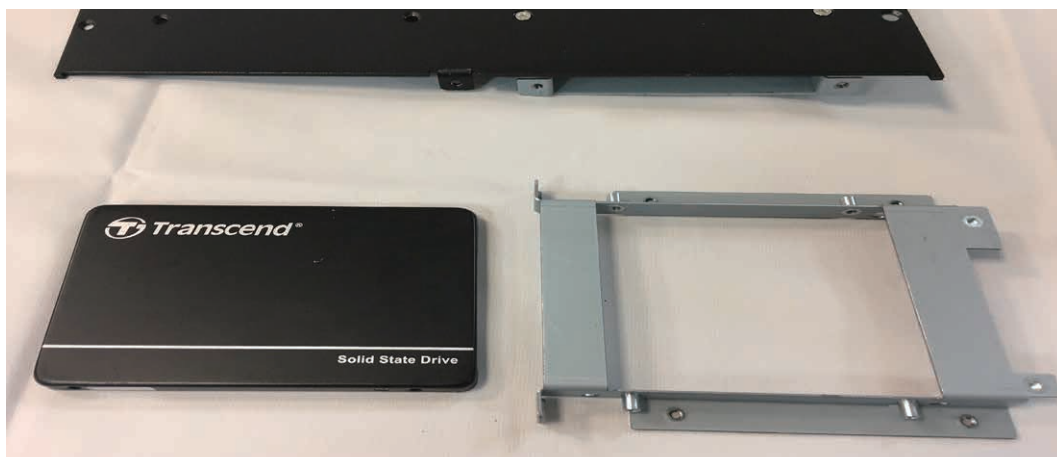

**Step 3** Lock KH-M3 screws. (One SSD/HDD with four KH-M3 screws)

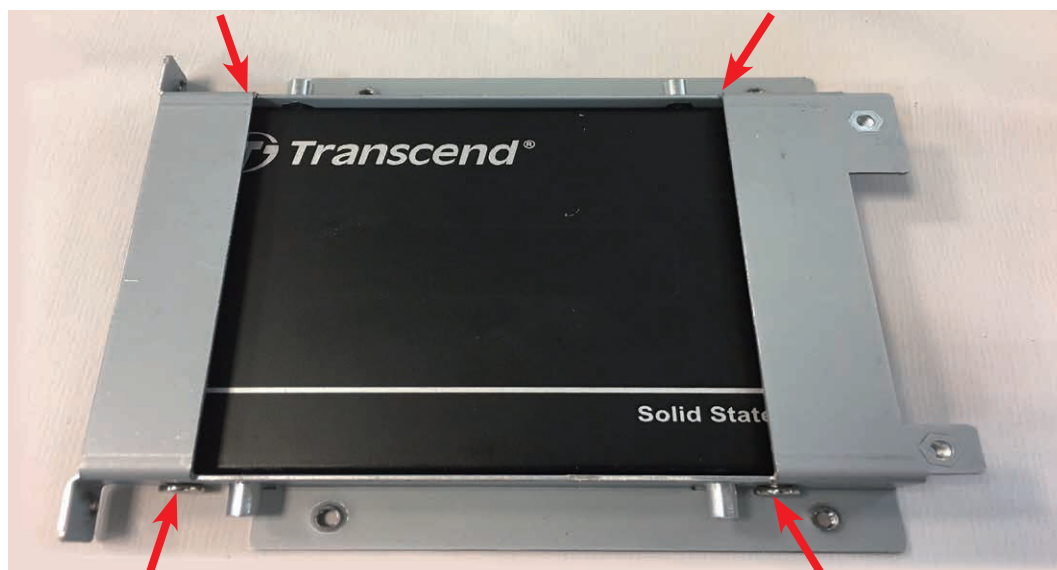

## 3.8 Mounting Your ECS-4500

### 3.8.1 Wall Mount Bracket

**Step 1** Ensure the screw holes on the right and left side of the upper case match the ones on ECS-4500 wall mount bracket.

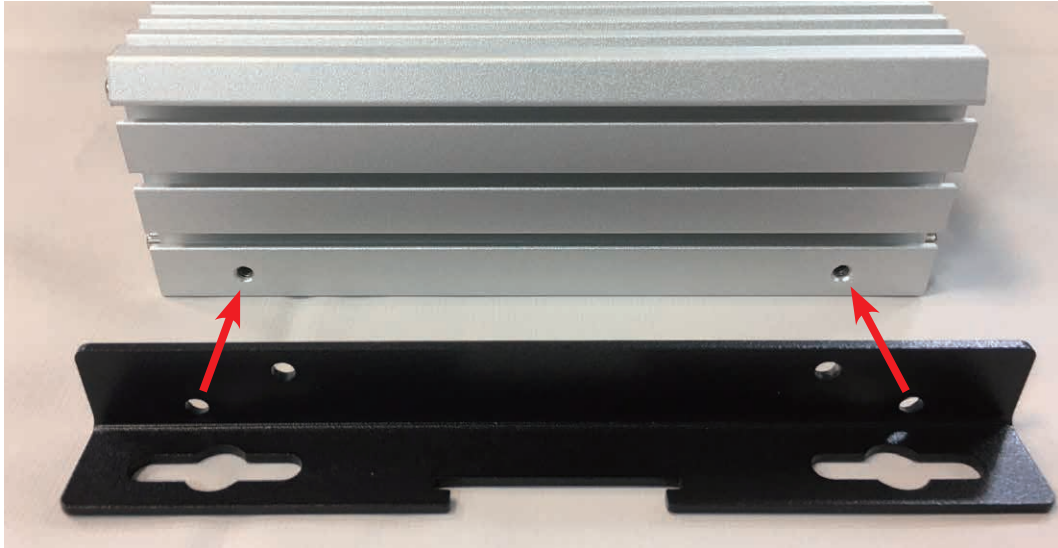

**Step 2** Fasten 4pcs KHS#6-32 screws and then finish.

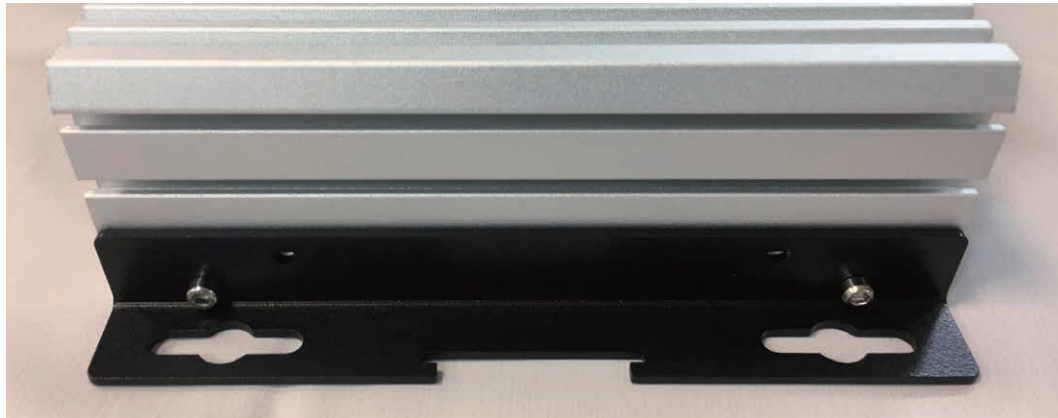

**Step 3** Finish.



### 3.8.2 VESA Mount

**Step 1** ECS-4500 and VESA Mount.

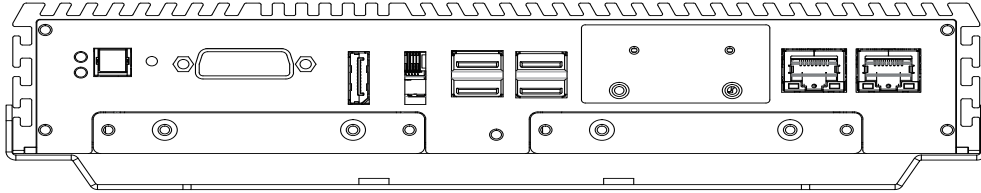

**Step 2** Take ECS-4500 and VESA Mount with fasten four KHS#6-32 screws.

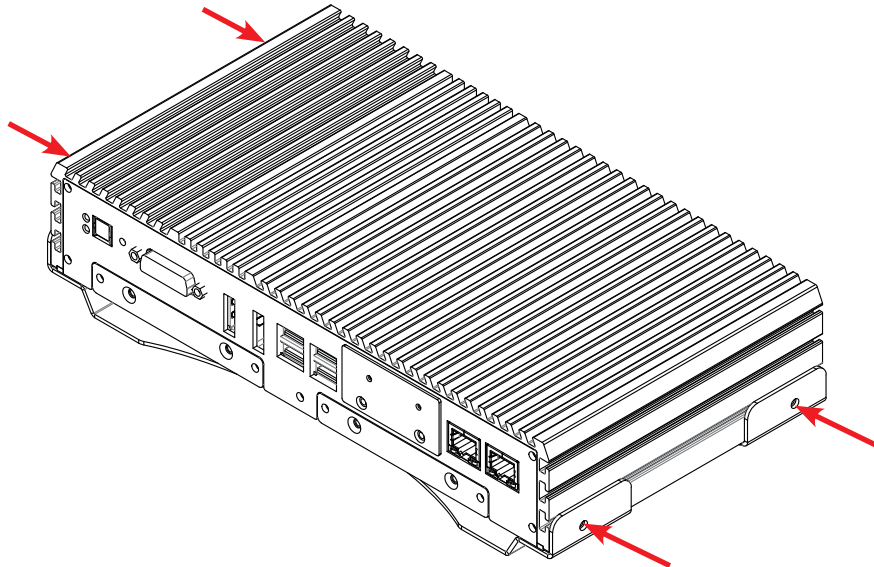

**Step 3** Finish.

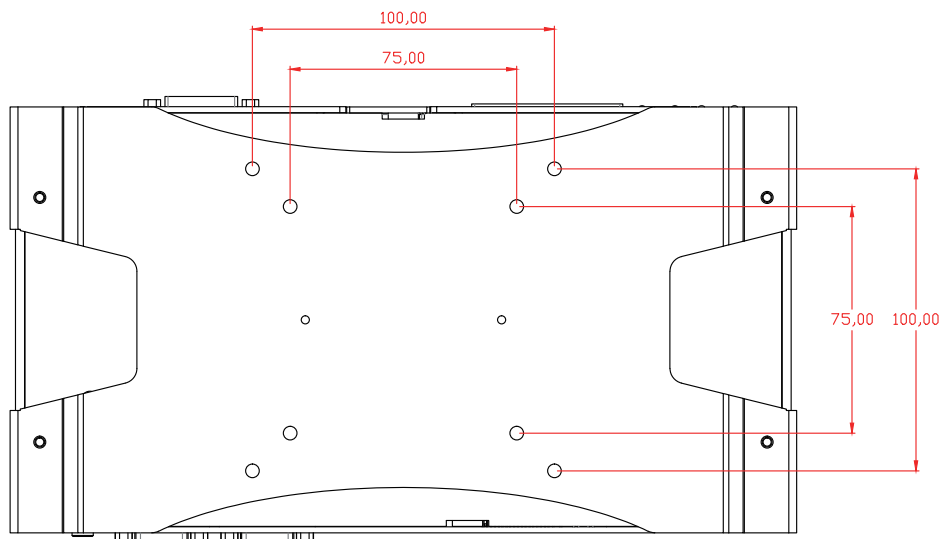

### 3.8.3 Din Rail Kit

**Step 1** ECS-4500 and Din Rail Kit.

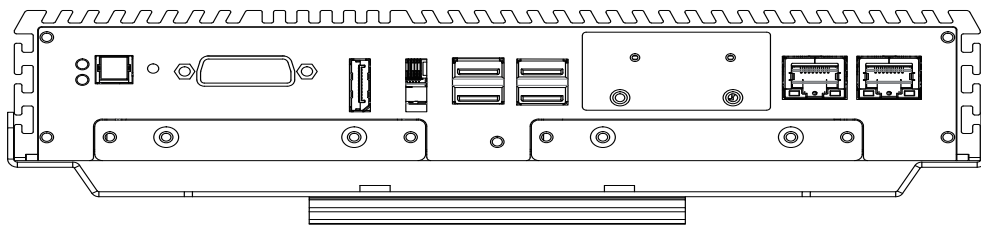

**Step 2** Take ECS-4500 and Din Rail Kit with fasten four KHS#6-32 screws.

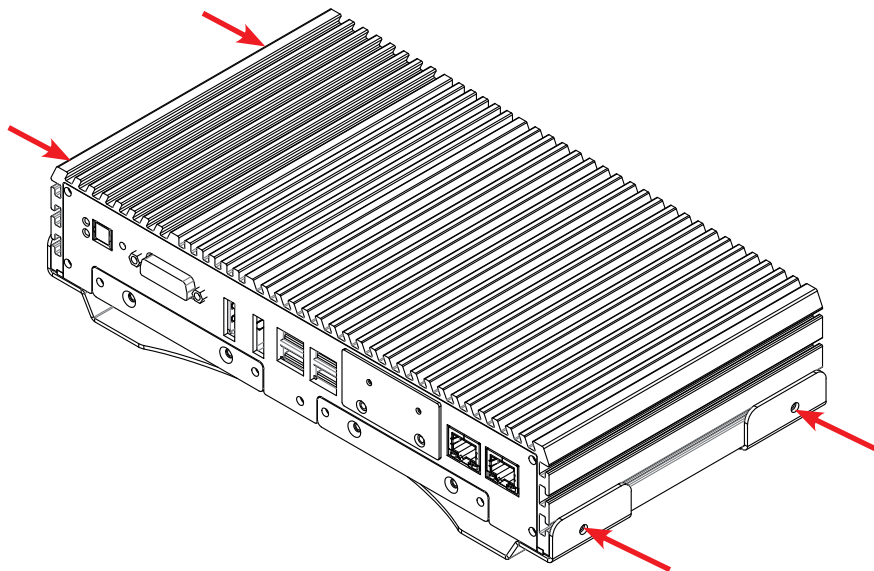

**Step 3** Finish.

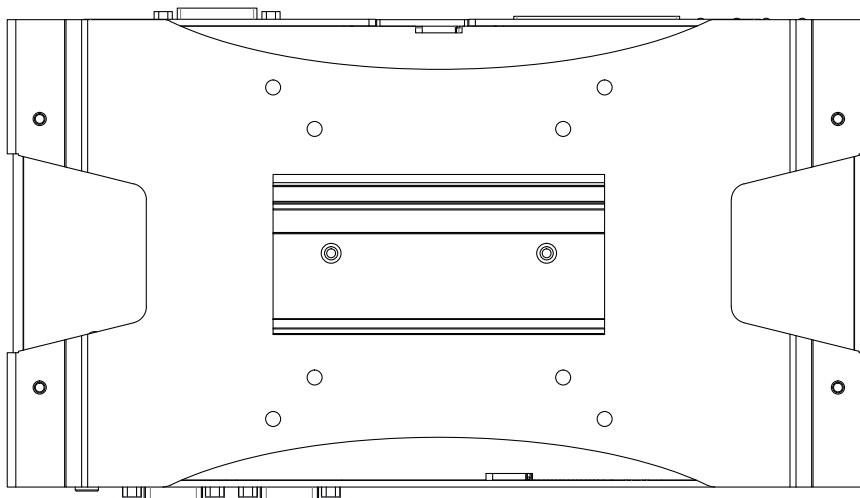

# 4

## BIOS SETUP

### 4.1 Entering BIOS SETUP

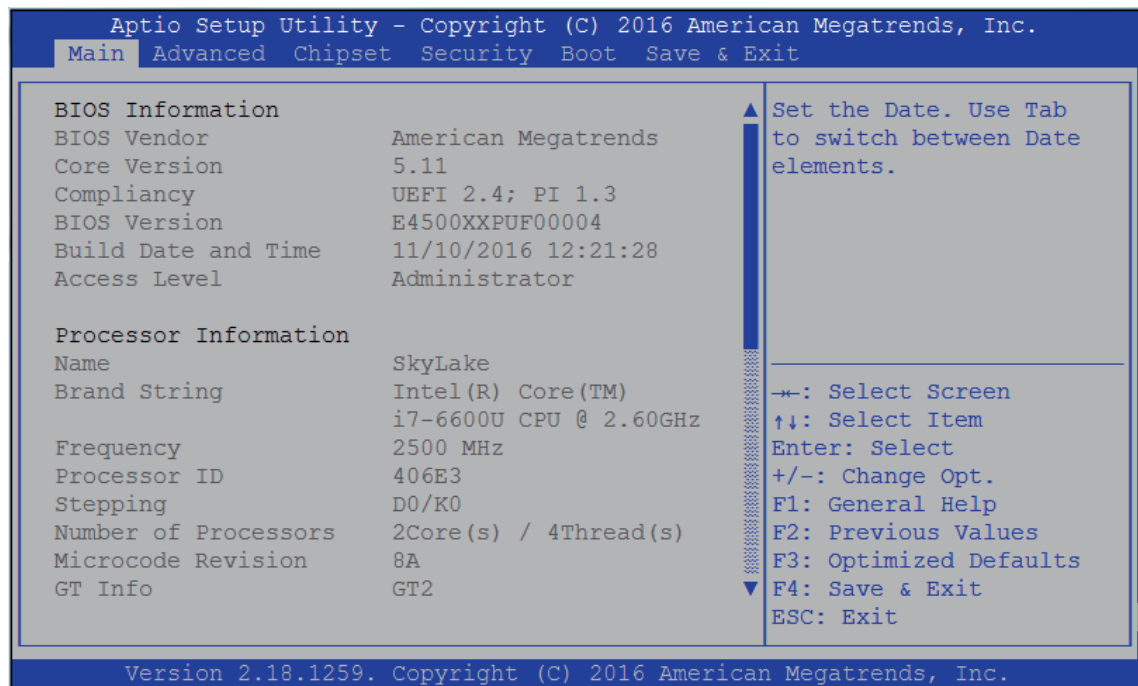

Figure 4-1: Entering Setup Screen

BIOS provides an interface for users to check and change system configuration. The BIOS setup program is accessed by pressing the <Del> key when POST display output is shown.

## 4.2 Main

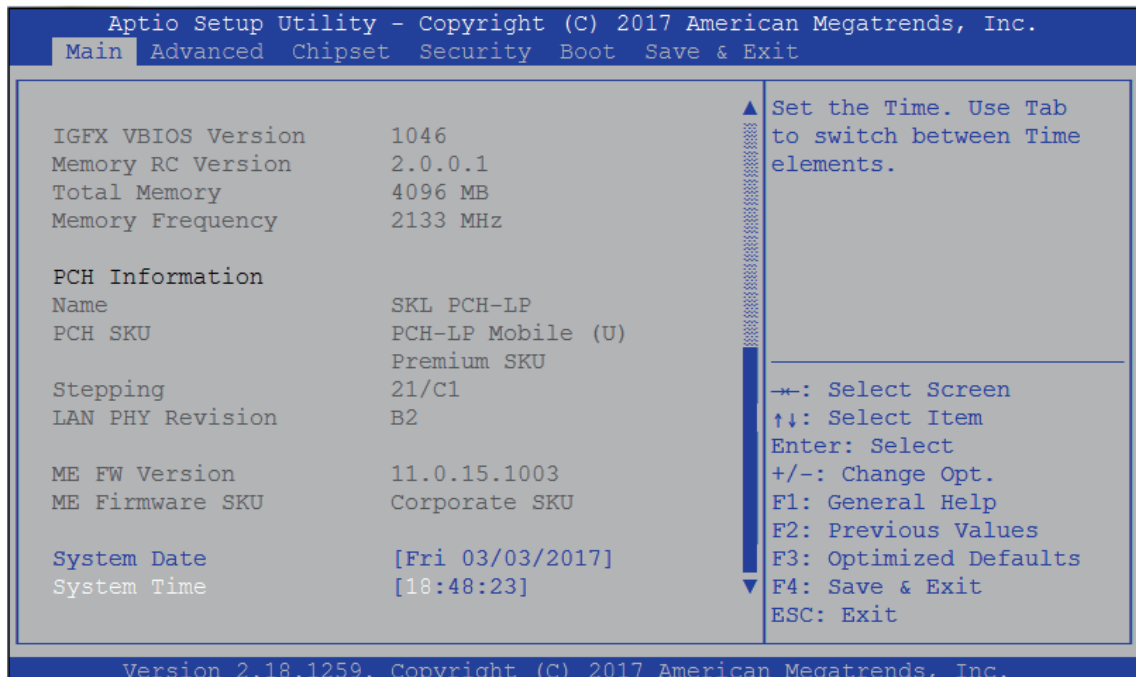

Figure 4-2: BIOS Main Menu

The main menu displays BIOS version and system information. There are two options on the main menu, system date and system time.

### System Date

Set the date. Use <Tab> to switch between date elements.

### System Time

Set the time. Use <Tab> to switch between time elements.

## 4.3 Advanced

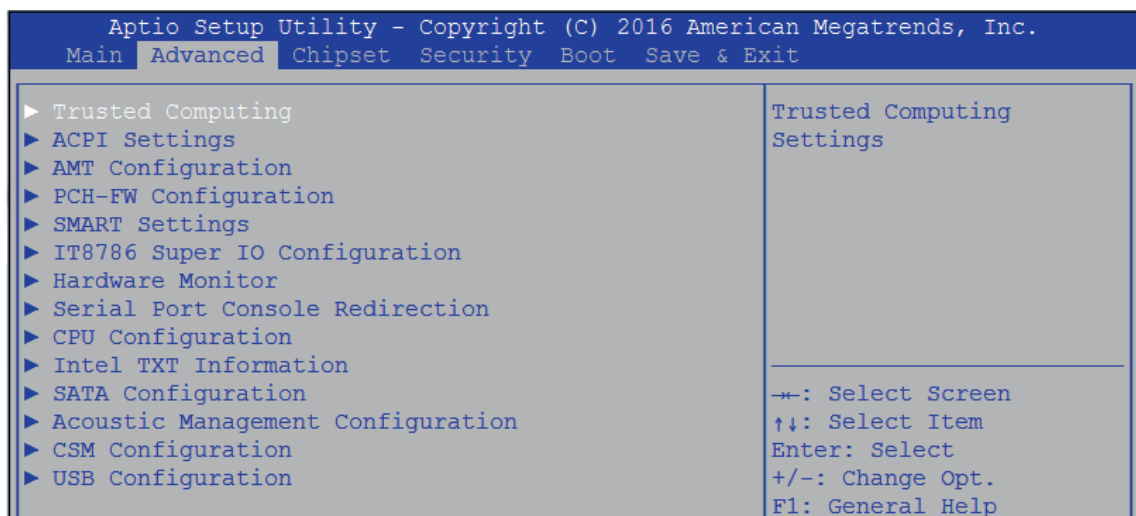

Figure 4 3: BIOS Advanced Menu

Select advanced tab to enter advanced BIOS setup options such as CPU configuration, SATA configuration, and USB configuration.

### 4.3.1 Trusted Computing

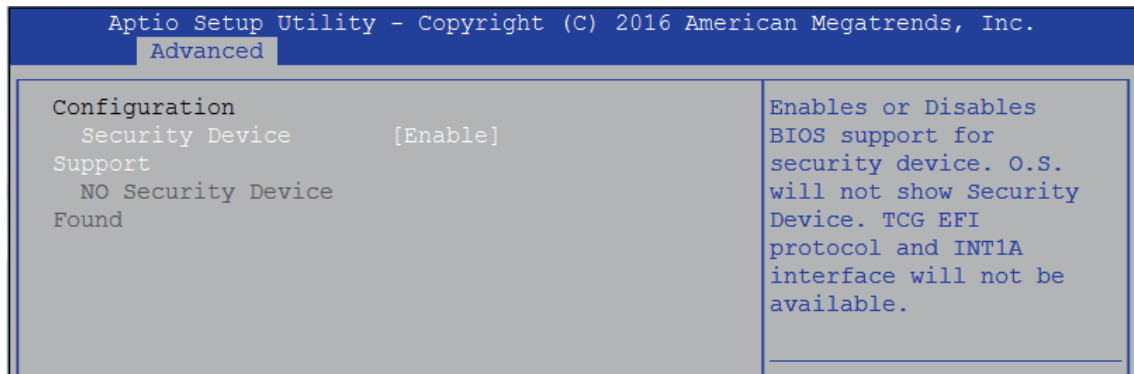

Figure 4 3-1: Trusted Computing

Control the TPM device status and display related information if TPM chip is present.

### 4.3.2 ACPI Settings

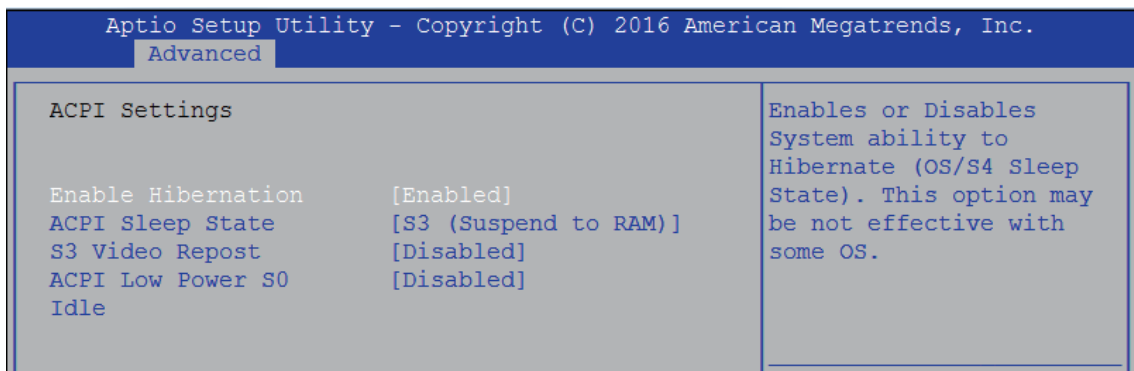

Figure 4 3-2: ACPI Settings

#### Enable Hibernation

Enables or disables system's ability to hibernate (OS/S4 sleep state). This option may not be effective with some OS.

#### ACPI Sleep State

Selects the highest ACPI sleep state the system will enter when the SUSPEND button is pressed.

#### S3 Video Repost

Enables or disables S3 video repost.

#### ACPI Low Power S0 Idle

Enables or disables ACPI low power S0 idle support.



### 4.3.3 AMT Configuration

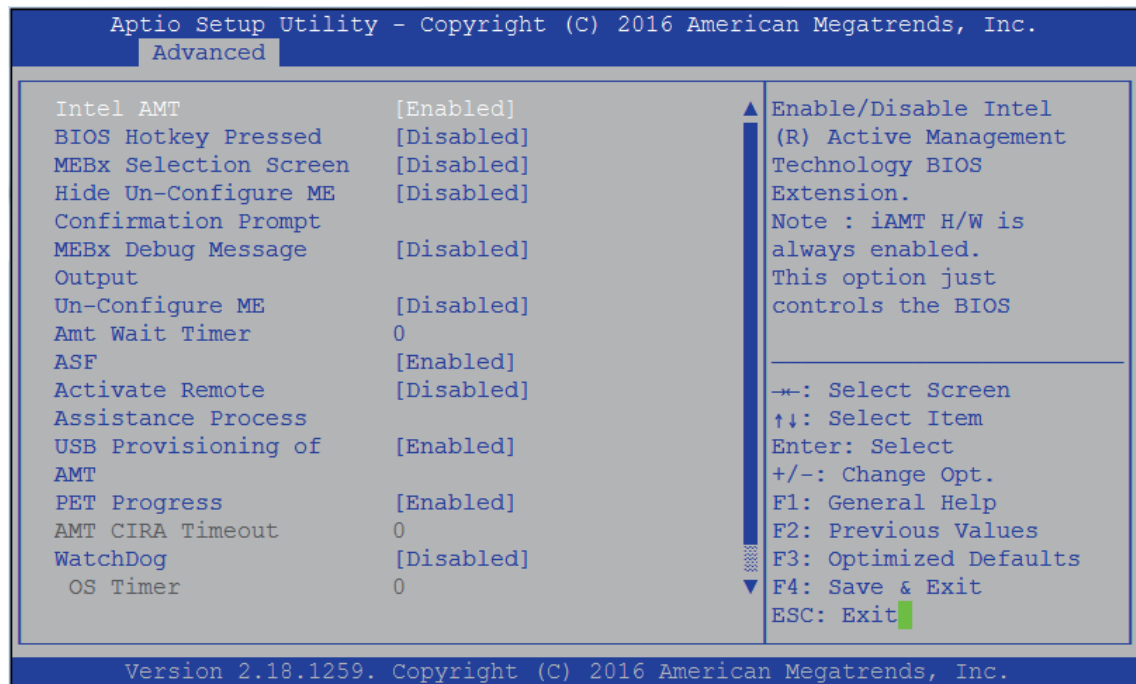

Figure 4 3-3: Intel AMT Settings

#### Intel AMT

Enables/disables Intel (R) Active Management Technology BIOS extension. Note: iAMT H/W is always enabled. This option just controls the BIOS extension execution. If enabled, this requires additional firmware in the SPI device.

### 4.3.4 PCH-FW Configuration

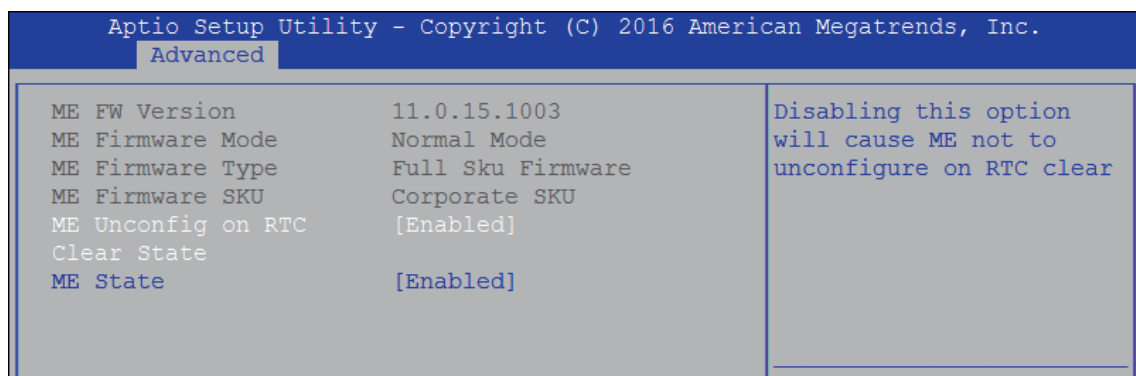

Figure 4 3-4: PCH-FW Settings

#### ME Unconfig on RTC Clear State

Disabling this option will cause ME not to unconfigure on RTC clear.

#### ME State

Set ME to Soft temporarily disabled.

### 4.3.5 SMART Settings

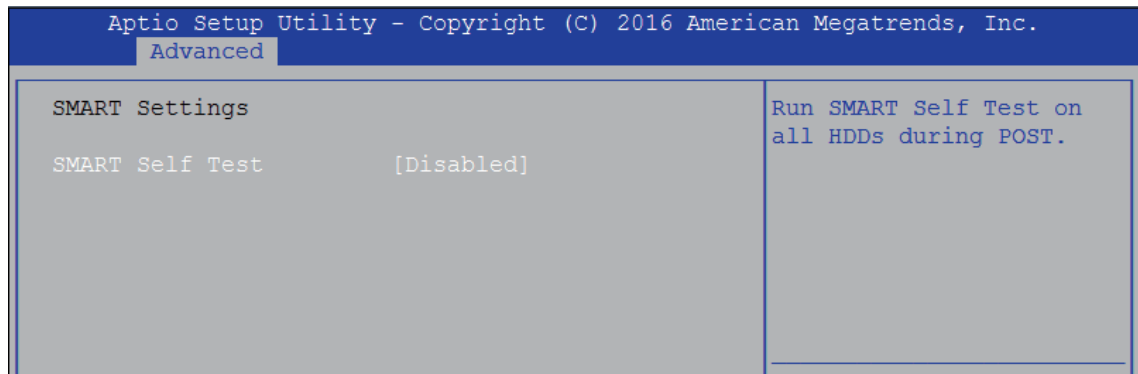

Figure 4 3-5: SMART Settings

#### SMART Self Test

Run SMART self test on all HDD's during POST.

### 4.3.6 IT8786 Super IO Configuration

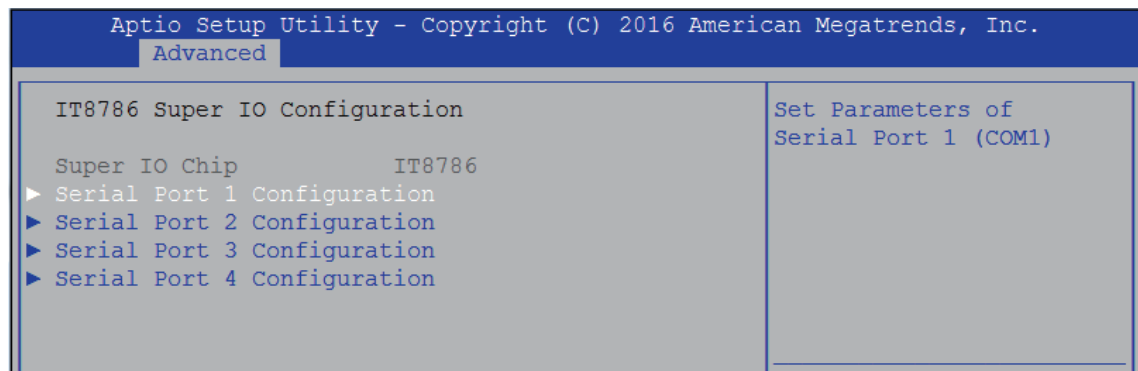

Figure 4-3-6: Super IO Settings

#### Serial Port 1 Configuration

Set parameters of serial port 1 (COM1).

#### Serial Port 2 Configuration

Set parameters of serial port 2 (COM2).

#### Serial Port 3 Configuration

Set parameters of serial port 3 (COM3).

#### Serial Port 4 Configuration

Set parameters of serial port 4 (COM4).

### 4.3.7 Hardware Monitor

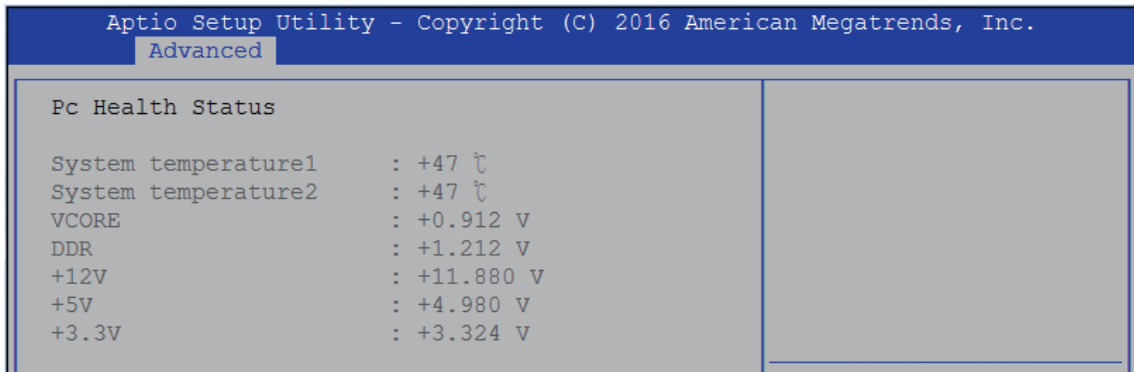

Figure 4 3-7: Hardware Monitor Settings

The IT8786 SIO features an enhanced hardware monitor providing thermal, fan speed, and system voltages' status monitoring.

### 4.3.8 Serial Port Console Redirection

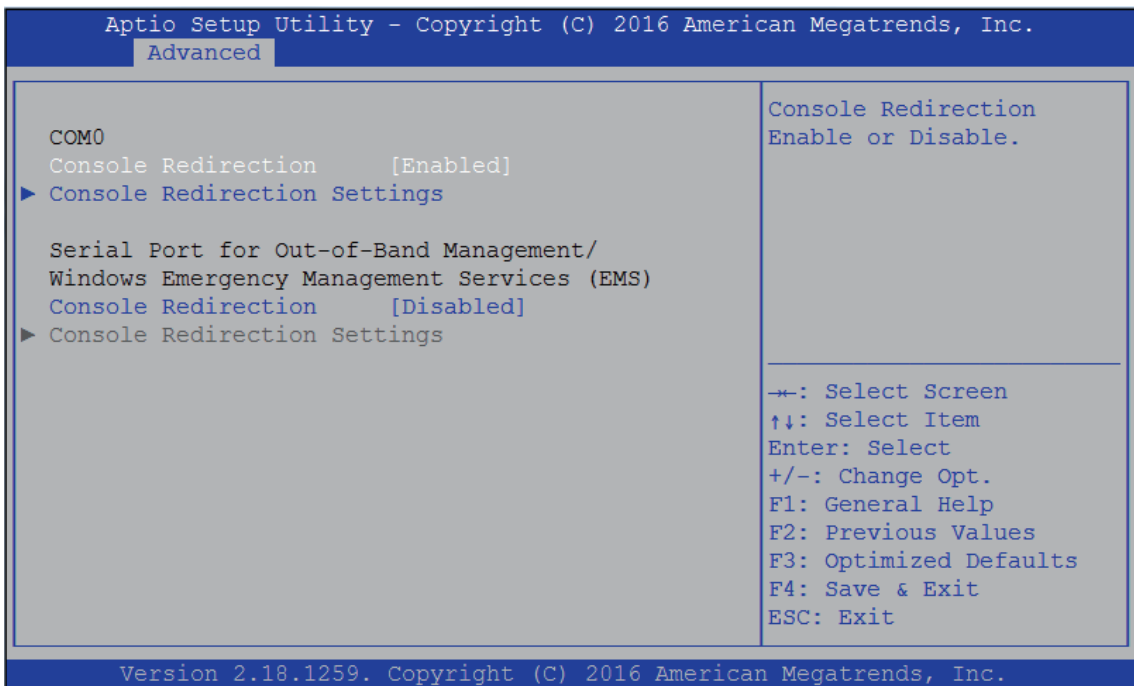

Figure 4 3-8: Serial Port Console Redirection Settings

#### Console Redirection

Console redirection enable or disable.

#### Console Redirection Settings

These settings specify how the host computer and the remote computer (which the user is using) will exchange data. Both computers should have the same or compatible settings.

### 4.3.9 CPU Configuration

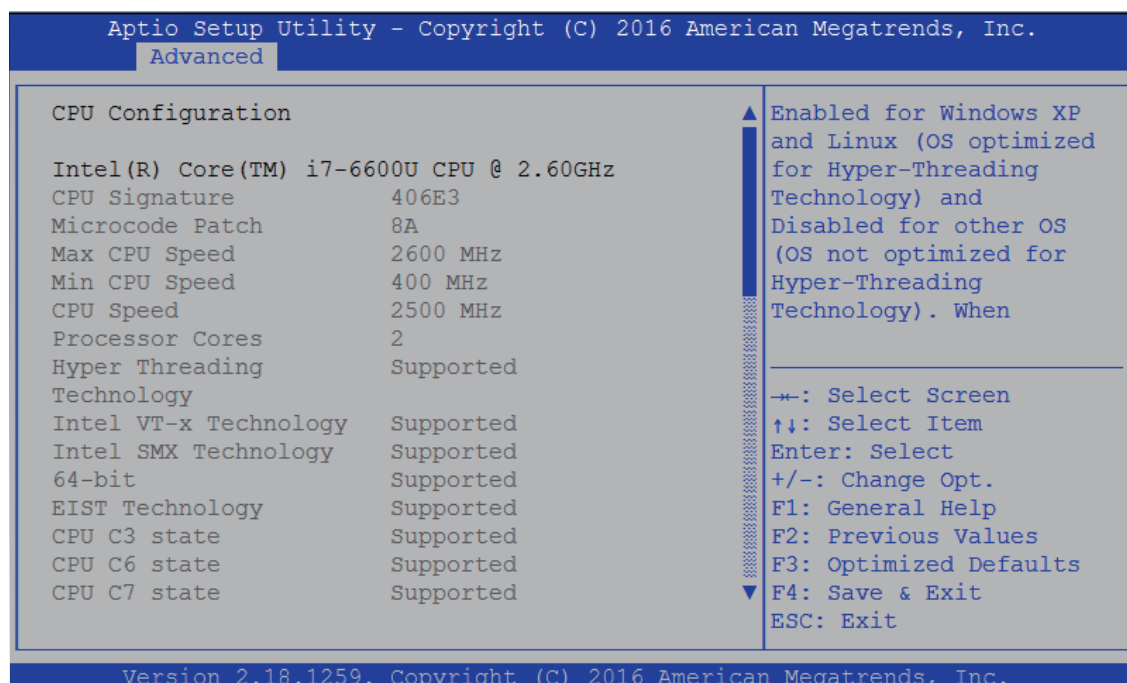

Figure 4 3-9: CPU Function Settings

#### Hyper-threading

Enabled for Windows XP and Linux (OS optimized for Hyper-Threading Technology) and disabled for other OS (OS not optimized for Hyper-Threading Technology). When disabled, only one thread per core is enabled.

#### Active Processor Cores

Number of cores to enable in each processor package.

#### Intel Virtualization Technology

When enabled, a VMM can utilize the additional hardware capabilities provided by Vanderpool Technology.

#### Hardware Prefetcher

To turn on/off the MLC streamer prefetcher.

#### Adjacent Cache Line Prefetch

To turn on/off prefetching of adjacent cache lines.

#### CPU AES

Enable/disable CPU Advanced Encryption Standard instructions.

#### Boot performance mode

Select the performance state that the BIOS will set before OS handoff.

#### Intel(R) SpeedStep(tm)

Allows more than two frequency ranges to be supported.

### Turbo Mode

Turbo Mode.

### CPU C state

Enable or disable CPU C states.

### Enhanced C-states

Enable/disable C1E. When enabled, CPU will switch to minimum speed when all cores enter C-State.

### Package C State limit

Package C State limit.

### Intel TXT(LT) Support

Enables or disables Intel (R) TXT (LT) support.

## 4.3.10 Intel TXT Information

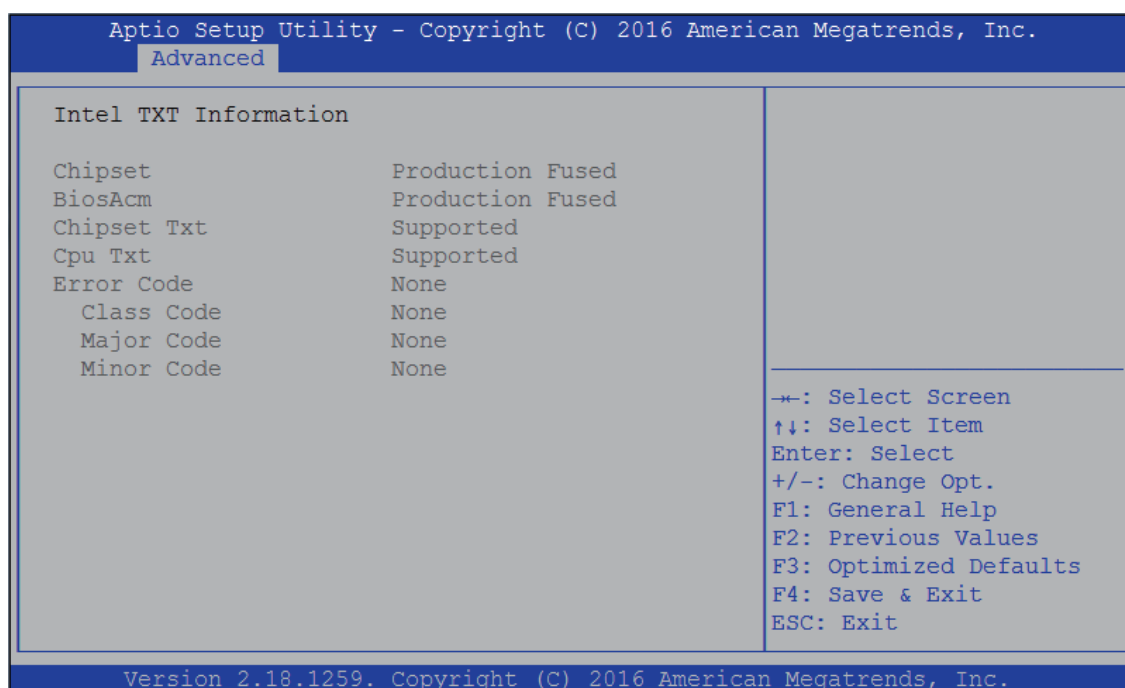

Figure 4 3-10: Intel TXT Information

Display Intel TXT information.

### 4.3.11 SATA Configuration

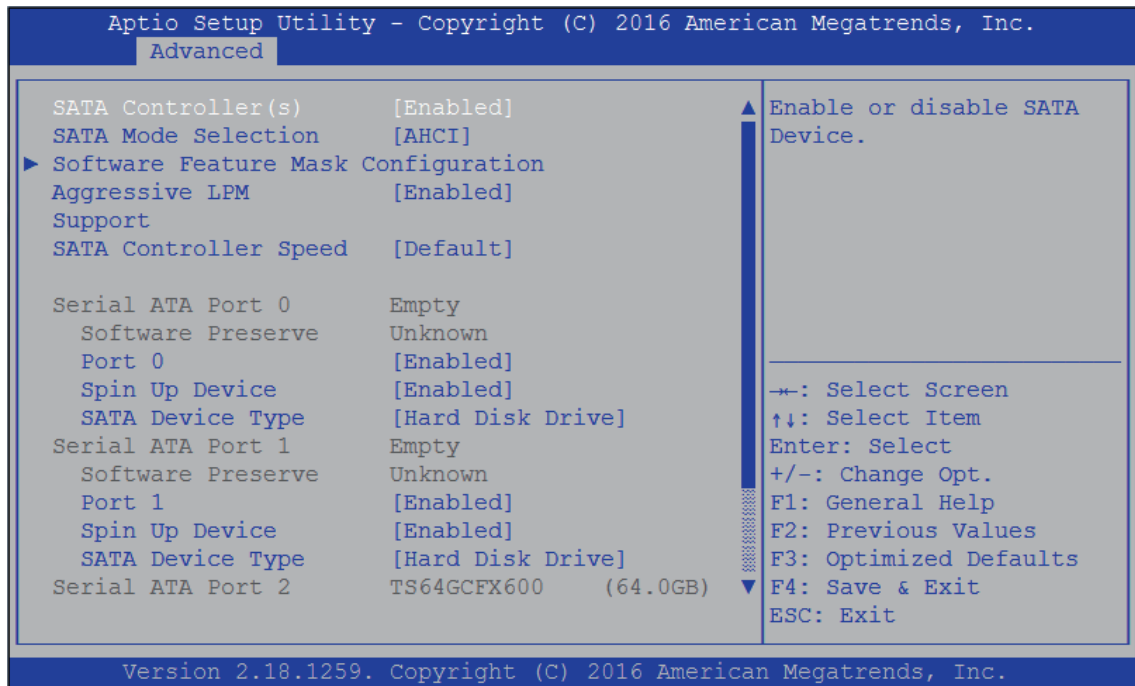

Figure 4 3-11: SATA Devices Settings

#### SATA Controller(s)

Enable or disable SATA Device.

#### SATA Mode Selection

Determines how SATA controller(s) operate.

#### Software Feature Mask Configuration

RAID OROM/RST driver will refer to the SWFM configuration to enable or disable the storage features.

#### Aggressive LPM Support

Enable PCH to aggressively enter link power state.

#### SATA Controller Speed

Indicates the maximum speed the SATA controller can support.

#### Options for each SATA port

##### Port 0

Enable or disable SATA Port.

##### SATA Device Type

Identifies that the SATA port is connected to solid state drive or hard disk drive.

### 4.3.12 Acoustic Management Configuration

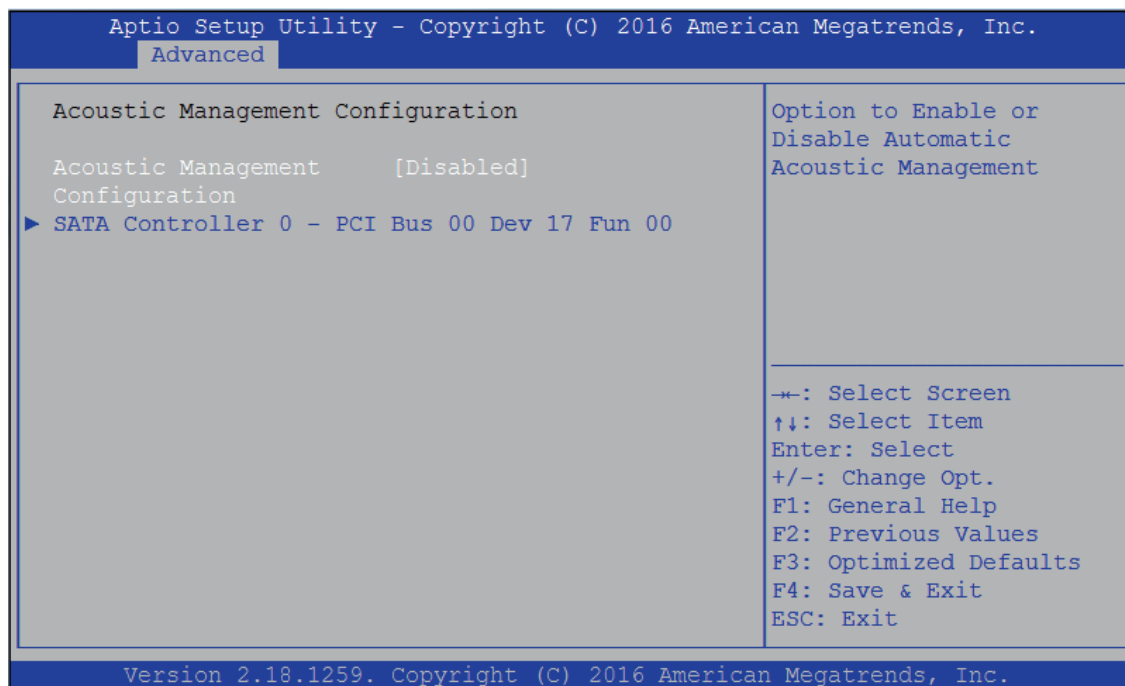

Figure 4 3-12: Acoustic Management Settings

#### Acoustic Management Configuration

Option to enable or disable automatic acoustic management.

### 4.3.13 CSM Configuration

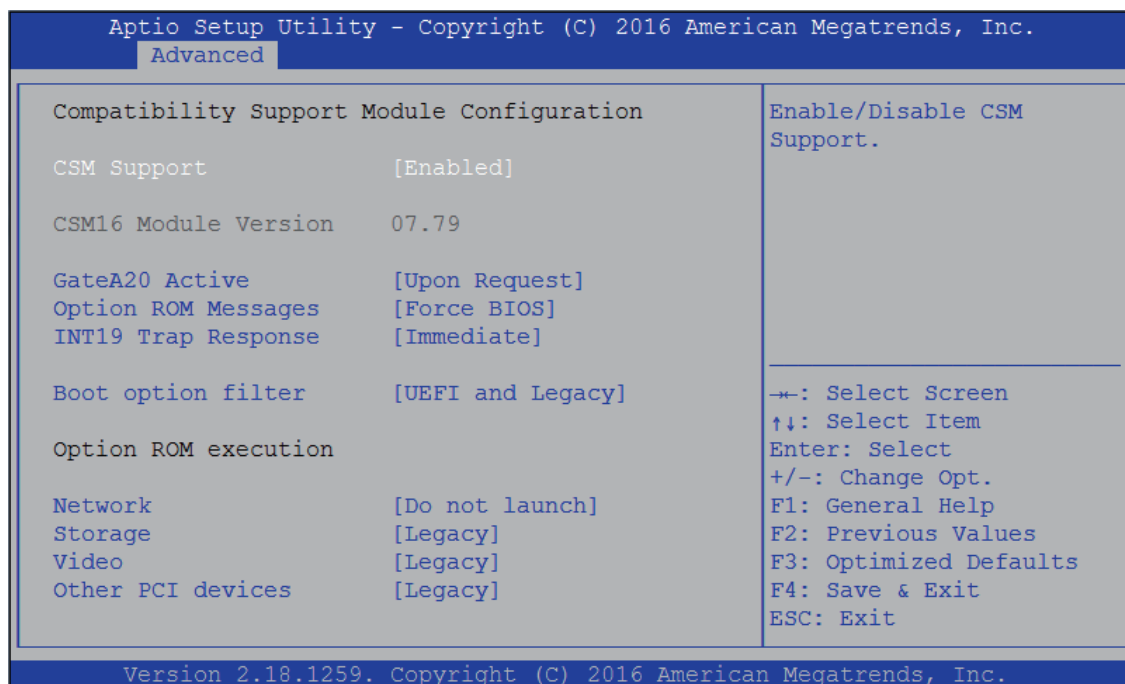

Figure 4 3-13: CSM Settings

### **CSM Support**

Enable/disable CSM support

### **GateA20 Active**

UPON REQUEST - GA20 can be disabled using BIOS services.

ALWAYS - do not allow GA20 to be disabled; this option is useful when any RT code is executed above 1MB.

### **Option ROM Messages**

Set display mode for Option ROM.

### **INT19 Trap Response**

BIOS reaction on INT19 trapping by Option ROM:

IMMEDIATE - execute the trap right away;

POSTPONED - execute the trap during legacy boot.

### **Boot option filter**

This option controls Legacy/UEFI ROM's priority.

### **Network**

Controls the execution of UEFI and Legacy PXE OpROM.

### **Storage**

Controls the execution of UEFI and Legacy Storage OpROM.

### **Video**

Allows more than two frequency ranges to be supported.

### **Other PCI devices**

Determines OpROM execution policy for devices other than network, storage, or video.



### 4.3.14 USB Configuration

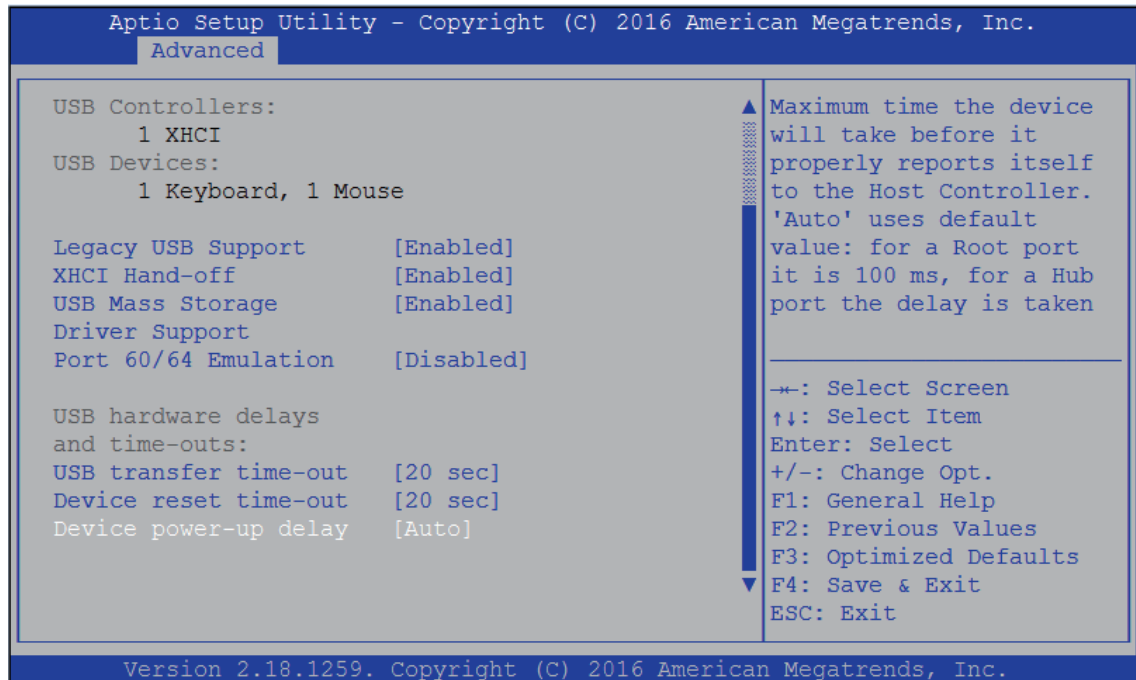

Figure 4 3-14: USB Settings

#### Legacy USB Support

Enables Legacy USB support.

AUTO option disables Legacy support if no USB devices are connected.

DISABLE option will keep USB devices available only for EFI applications.

#### XHCI Hand-off

This is a workaround for OS-es without XHCI hand-off support. The XHCI ownership change should be claimed by XHCI driver.

#### USB Mass Storage Driver Support

Enable/disable USB mass storage driver support.

#### Port 60/64 Emulation

Enables I/O port 60h/64h emulation support. This should be enabled for the complete USB keyboard legacy support for non-USB aware OS-es.

#### USB transfer time-out

The time-out value for control, bulk, and interrupt transfers.

#### Device reset time-out

USB mass storage device start unit command time-out.

#### Device power-up delay

Maximum time the device will take before it properly reports itself to the Host Controller. 'Auto' uses default value, for a root port it is 100 ms, for a hub port the delay is taken from the hub descriptor.

## 4.4 Chipset

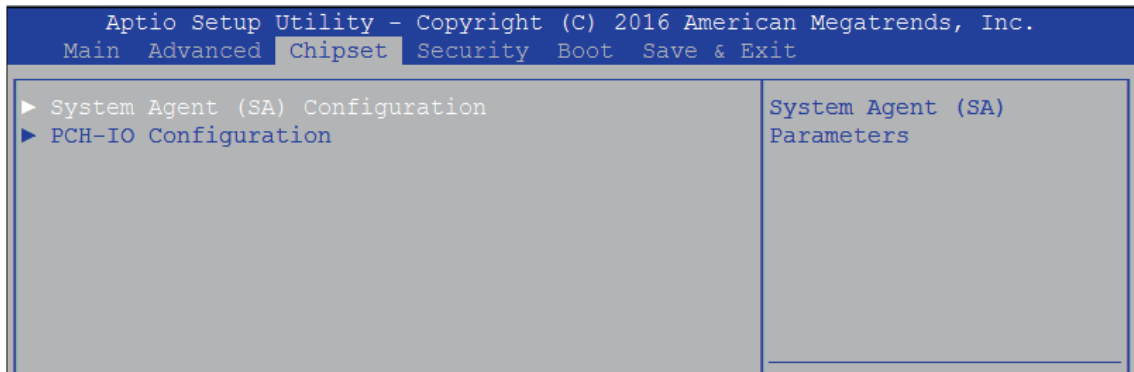

Figure 4-4: BIOS Chipset Menu

### System Agent (SA) Configuration

System Agent (SA) parameters.

### PCH-IO Configuration

PCH parameters.

#### 4.4.1 System Agent (SA) Configuration

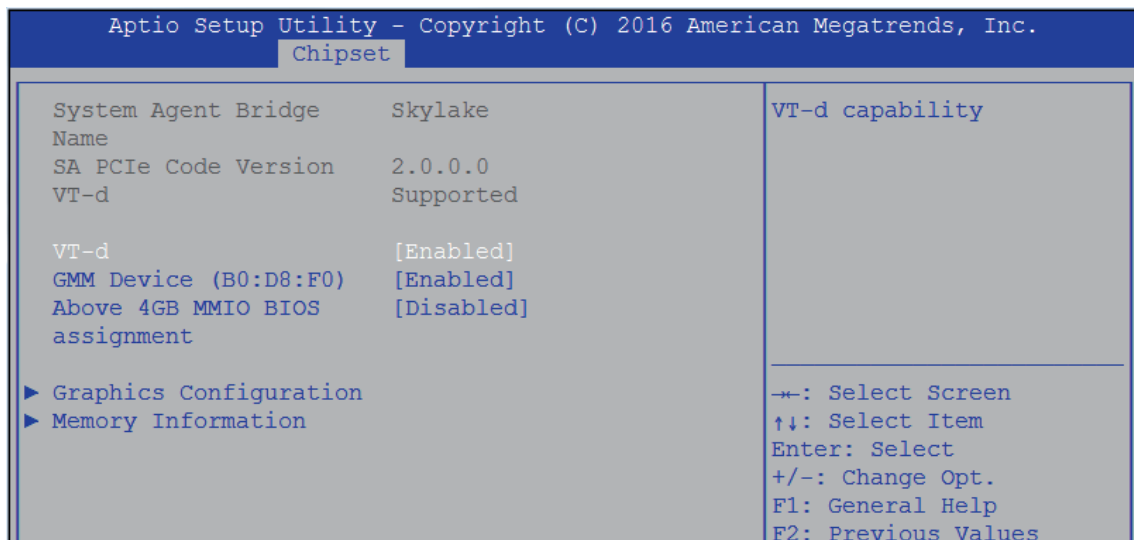

Figure 4-4-1: System Agent Settings

### VT-d

VT-d capability.

### GMM Device (B0:D8:F0)

Enable/disable SA GMM device.

### Above 4GB MMIO BIOS assignment

Enable/disable above 4GB MemoryMappedIO BIOS assignment. This is disabled automatically when aperture size is set to 2048MB.

## 4.4.2 Graphics Configuration

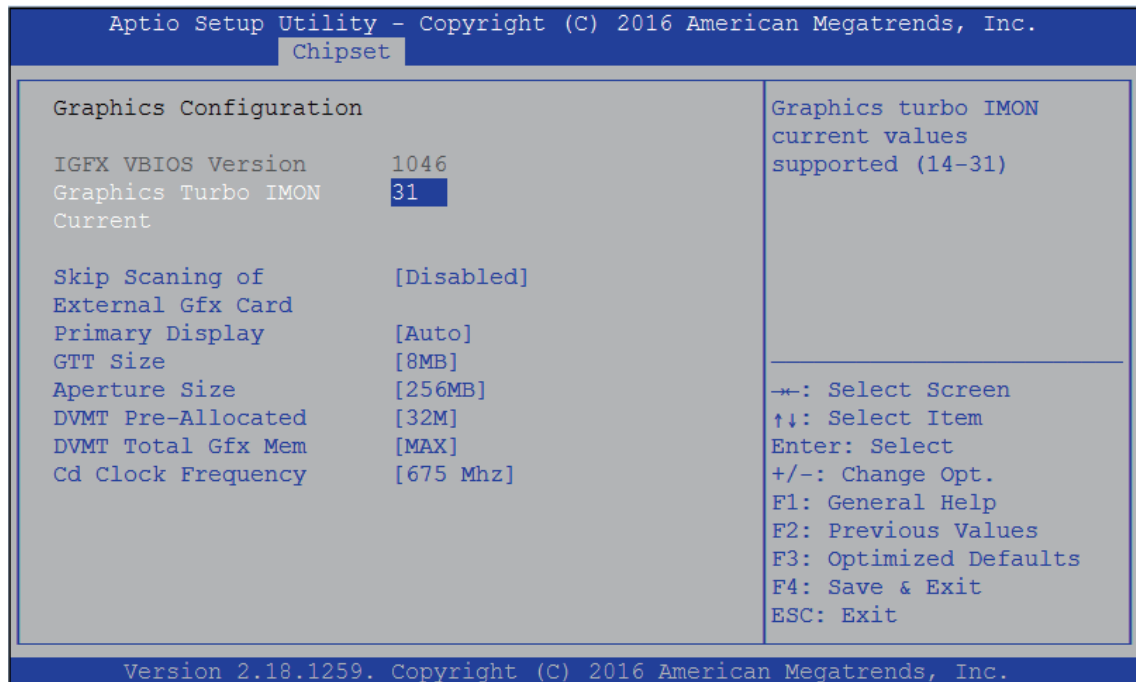

Figure 4-4-2: Graphics Settings

### Skip Scanning of External Gfx Card

If Enable, it will not scan for External Gfx Card on PEG and PCH PCIE Ports.

### GTT Size

Select the GTT Size.

### Aperture Size

Select the Aperture Size.

Note: Above 4GB MMIO BIOS assignment is automatically enabled when selecting 2048MB aperture. To use this feature, please disable CSM Support.

### DVMT Pre-Allocated

Select DVMT 5.0 pre-allocated (fixed) graphics memory size used by the internal graphics device.

### DVMT Total Gfx Mem

Select DVMT5.0 Total Graphic Memory size used by the Internal Graphics Device.

### Cd Clock Frequency

Select the highest Cd Clock frequency supported by the platform.

### 4.4.3 Memory Information

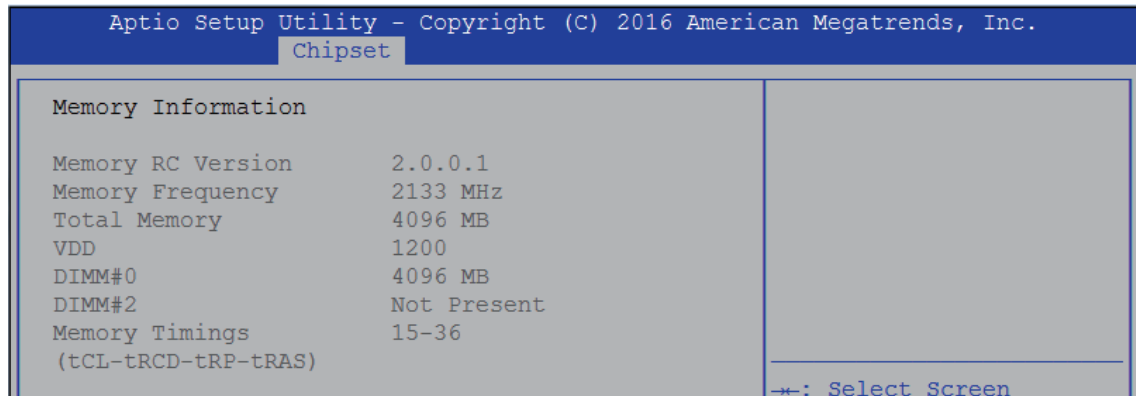

Figure 4-4-3: Memory Information

### 4.4.4 PCH-IO Configuration

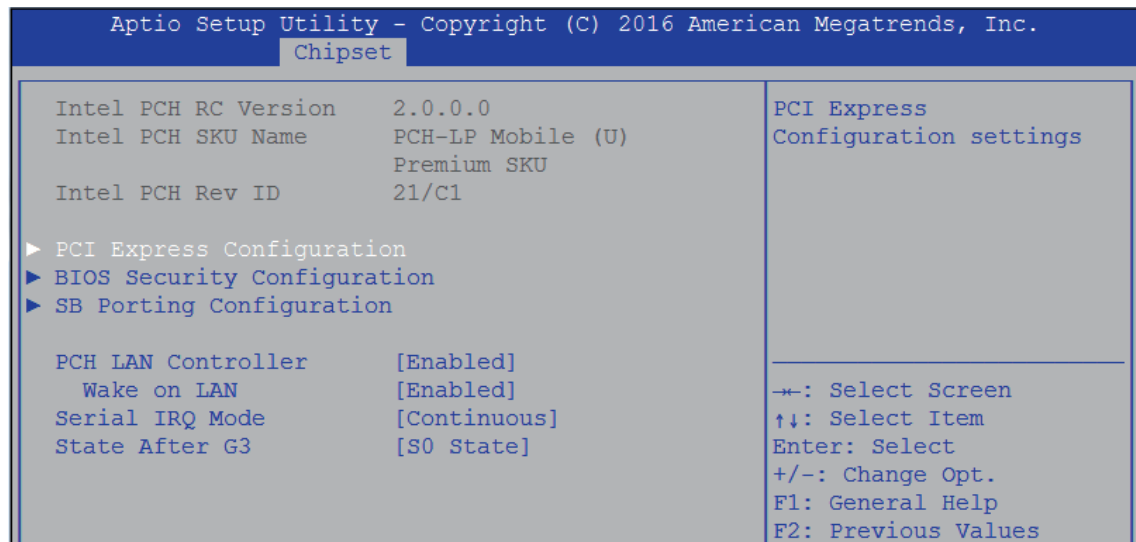

Figure 4-4-4: PCH-IO Settings

#### PCH LAN Controller

Enable or disable onboard NIC.

#### Wake on LAN

Enable or disable integrated LAN to wake the system. (The wake On LAN cannot be disabled if ME is on at Sx state.)

#### Serial IRQ Mode

Configure serial IRQ mode.

#### State After G3

Specify what state to go to when power is re-applied after a power failure (G3 state).

S0 State: Always turn-on the system when power source plugged-in.

S5 State: Always turn-off the system when power source plugged-in.

## 4.4.5 PCI Express Configuration

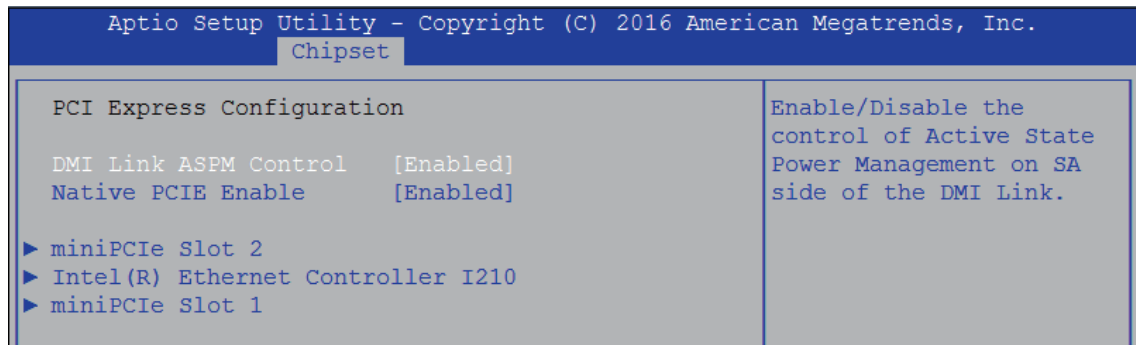

Figure 4-4-5: PCH-IO Settings

### DMI Link ASPM Control

Enable/disable the control of active state power management on SA side of the DMI link.

### Native PCIE Enable

PCI Express Native Support Enable/Disable. This feature is available in vista and beyond Windows OS.

## 4.4.6 BIOS Security Configuration

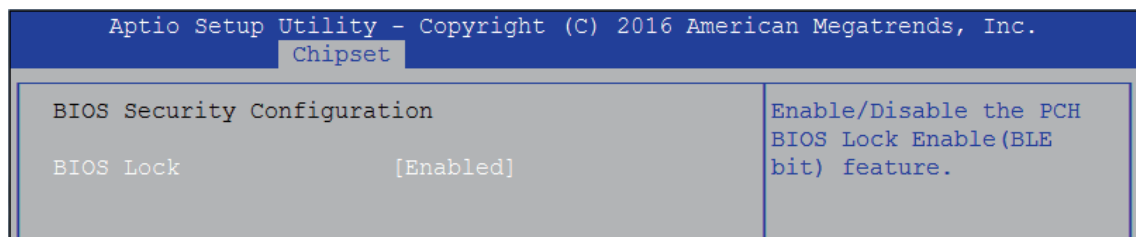

Figure 4-4-6: BIOS Security Settings

### BIOS Lock

Enable/disable the PCH BIOS Lock Enable (BLE bit) feature.

## 4.4.7 SB Porting Configuration

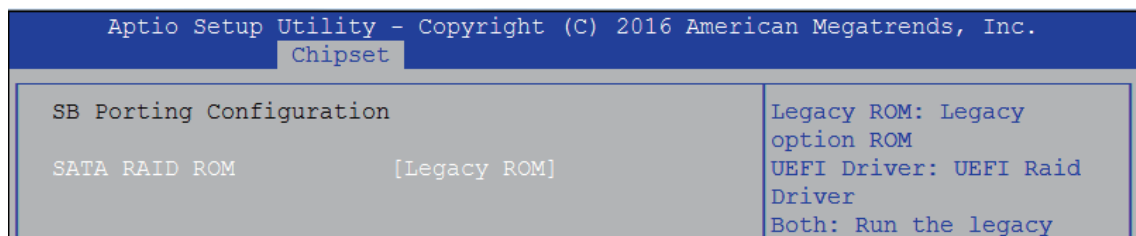

Figure 4-4-7: RAID ROM Settings

### SATA RAID ROM

Legacy ROM: Legacy option ROM

UEFI Driver: UEFI Raid Driver

Both: Run the Legacy Option ROM and UEFI driver.

## 4.5 Security

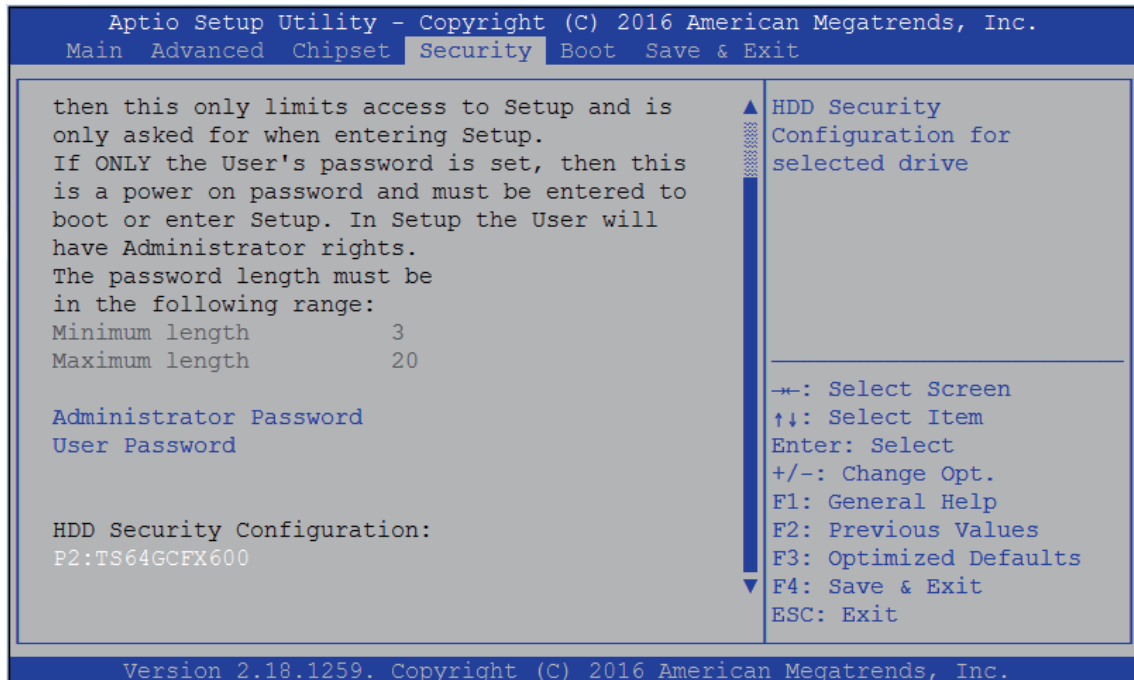

Figure 4-5: BIOS Security Menu

### Administrator Password

Set administrator password.

### User Password

Set user password.

### 4.5.1 HDD Security Configuration

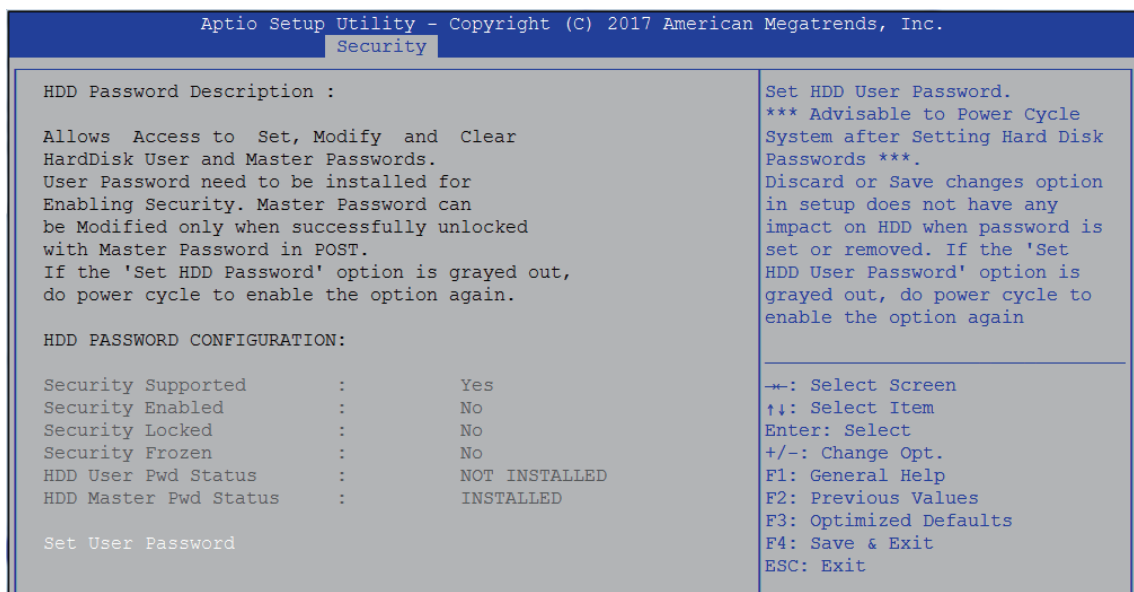

Figure 4-5-1: HDD Security Settings

## Set User Password

Set HDD user password.

\*\*\* Advisable to power cycle system after setting hard disk passwords \*\*\*

Discard or save changes option in setup does not have any impact on HDD when password is set or removed. If the 'Set HDD User Password' option is gray, do power cycle to enable the option again.

## 4.6 Boot

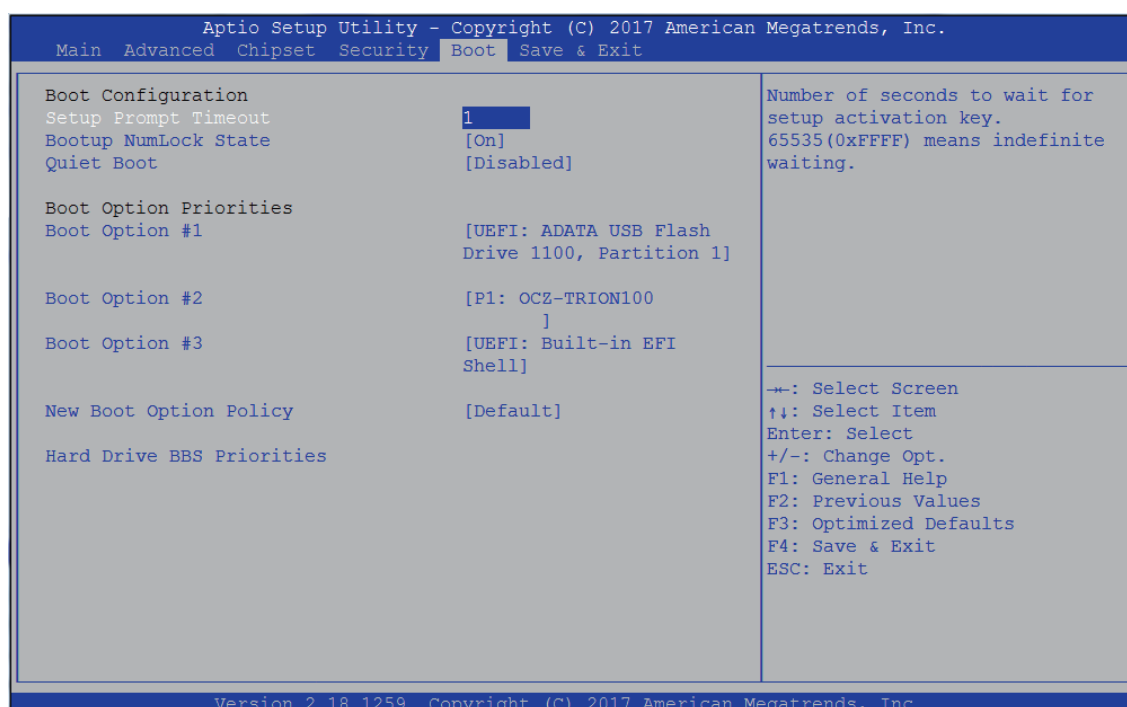

Figure 4-6: BIOS Boot Menu

### Setup Prompt Timeout

Number of seconds to wait for setup activation key. 65535(0xFFFF) means indefinite waiting.

### Bootup NumLock State

Select the keyboard NumLock state.

### Quiet Boot

Enables or disables Quiet Boot option.

### Boot Option #x

Sets the system boot order.

### New Boot Option Policy

Controls the placement of newly detected UEFI boot options.

### Hard Drive BBS Priorities

Set the order of the Legacy devices in this group.

## 4.7 Save & Exit

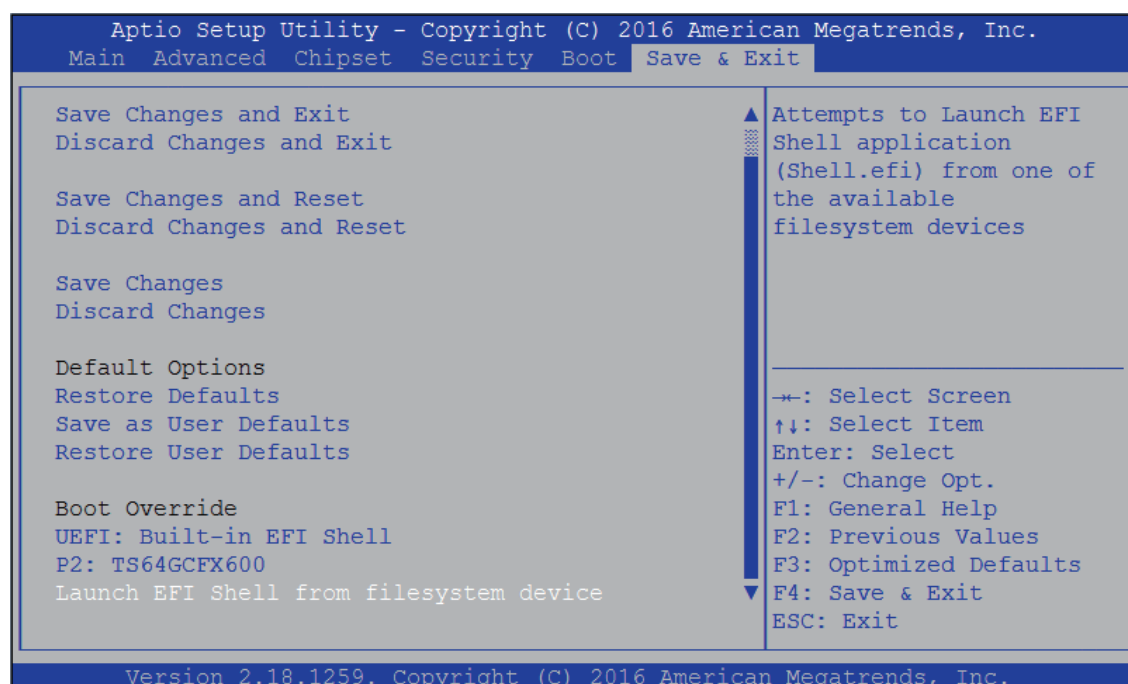

Figure 4-7: Bios Save and Exit Menu

### Save Changes and Exit

Exit system setup after saving the changes.

### Discard Changes and Exit

Exit system setup without saving any changes.

### Save Changes and Reset

Reset the system after saving the changes.

### Discard Changes and Reset

Reset system setup without saving any changes.

### Save Changes

Save changes done so far to any of the setup options.

### Discard Changes

Discard changes done so far to any of the setup options.

### Default Options:

#### Restore Defaults

Restore/load default values for all the setup options.

#### Save as User Defaults

Save the changes done so far as user defaults.

#### Restore User Defaults

Restore the user defaults to all the setup options.



# A

## APPENDIX A : Isolated DIO Guide

### A.1 Function Description

The ECS-4500 series offers a 16-bit DIO (8-DI/ 8-DO) 20-pin terminal block connector. Each bit of DI and DO equipped with a photo-coupler for isolated protection. All IO pins are fixed by Hardware design and cannot change in/out direction in runtime process. The definition is listed as follows:

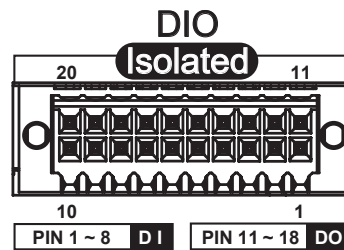

Pin No.	Definition	Description	Pin No.	Definition	Description
1	EXT_IN0	DI0	11	EXT_OUT0	DO0
2	EXT_IN1	DI1	12	EXT_OUT1	DO1
3	EXT_IN2	DI2	13	EXT_OUT2	DO2
4	EXT_IN3	DI3	14	EXT_OUT3	DO3
5	EXT_IN4	DI4	15	EXT_OUT4	DO4
6	EXT_IN5	DI5	16	EXT_OUT5	DO5
7	EXT_IN6	DI6	17	EXT_OUT6	DO6
8	EXT_IN7	DI7	18	EXT_OUT7	DO7
9	DI_COM	DI COM	19	Reserved	NC
10	EGND	DIO GND	20	E24V	External 24V DC

## A.2 DIO Signal Circuit

DI reference circuit:

Sink Mode (NPN)

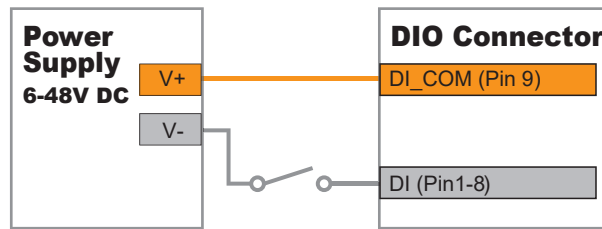

Source Mode (PNP)

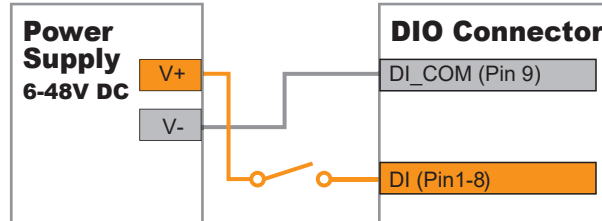

DO reference circuit:

Sink Mode  
(NPN, Default)

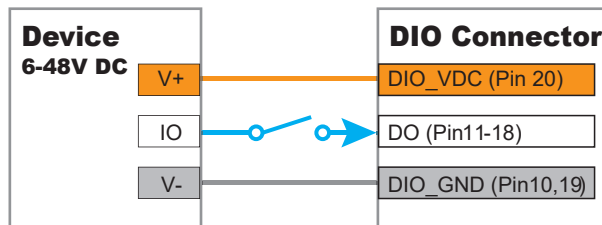

Source Mode  
(PNP)

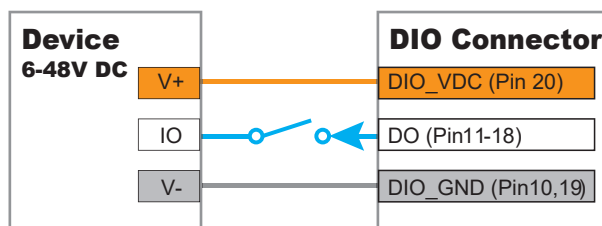

## A.3 Software Package contain

Distribution folder include x32 and x64 versions, use batch file for installation. Win7\_64.bat included Windows Update packages which driver required (OS need to Restart after installing). If the OS version is Windows 8/8.1/10 the batch file Win8\_32.bat, Win8\_64.bat, Win10\_32.bat, and Win10\_64.bat will install Framework 3.5 distribution for the sample utility.

If Source code compile by Framework 4 it doesn't need to install above batch file. Run batch file as Administrator. Runtime folder include head file for software developer or System Integration. Sample folder include Sample program, Driver package, and Driver API library. Source folder include Sample program source code that compile on Visual Studio 2008.

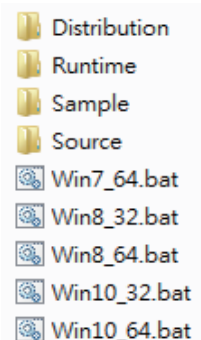

This driver support to 32bit and 64bit version that are Windows 7 above. Please make Sure you OS before you install it.

## A.4 DIO Demo Tool

Execute DIO Demo tool (ECS4K5.exe).

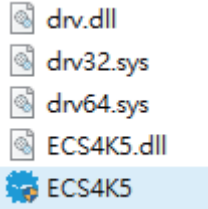

Run install.exe before testing.

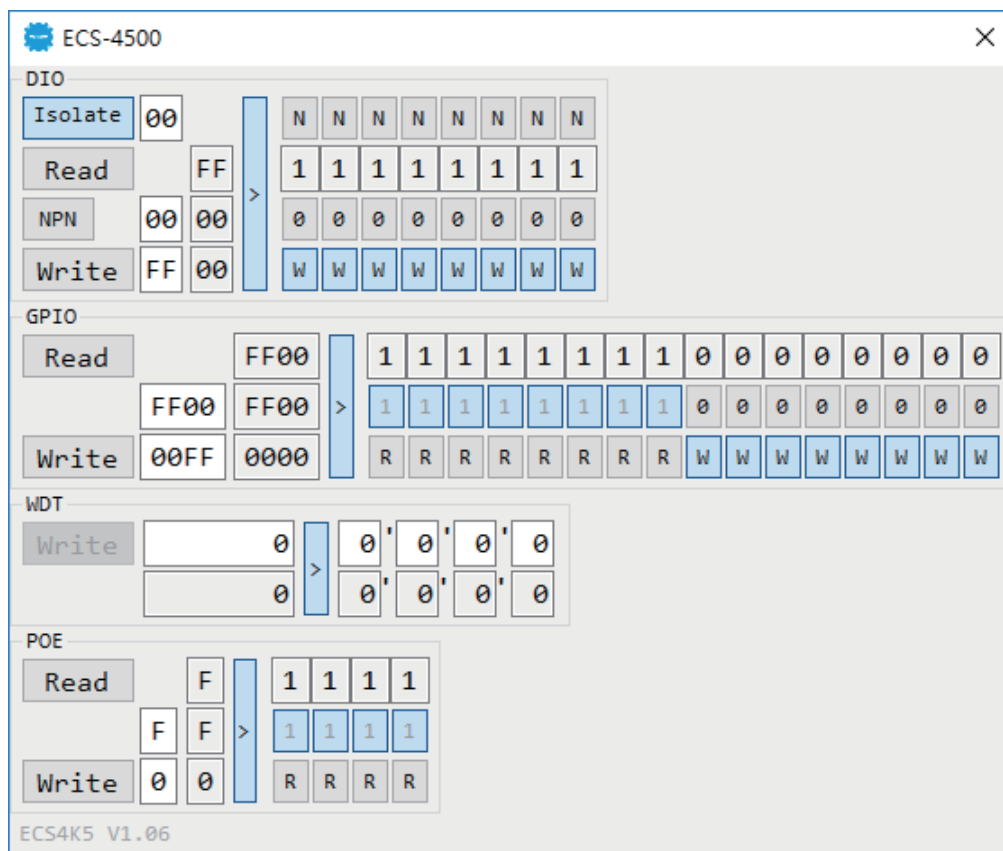

Operation on DIO Demo tool utility.

Click “Isolate” checked button for isolate/non-isolated DIO setup (customized version);

Click “N”/“P” checked button for DI NPN/PNP setup (or change textbox value);

Click “NPN”/“PNP” checked button for DO NPN/PNP setup;

Click “Read” button to get value;

Input any number in Write and Write Mask textbox, and click “Write” Button to set value;

Click “Stop” button to cancel WDT (watchdog timer) counter.

# B

## APPENDIX B : GPIO\_WDT Functions

### B.1 1 ECS4K5.DII API

#### **BOOL Initial(BYTE Isolate\_Type, BYTE DIO\_NPN);**

Install driver and initial machine for DIO access

Isolate\_Type: DIO Isolate Type

1: Isolated DIO; 0: Non-Isolated DIO

DIO\_NPN: DIO NPN mode

1: PNP (Source) mode for European rule; 0: NPN (Sink) mode for Japanese rule

Return:

TRUE (1): Success; FALSE (0): Fail (Install error (privilege error, or driver not work), or Initial error, or Parameter format error)

#### **BOOL GetDIO1Config(BYTE \*Isolate\_Type, BYTE \*DI\_NPN, BYTE \*DO\_NPN, WORD \*Mask);**

Get DIO1 configuration

Isolate\_Type: DIO1 Isolate Type

1: Isolated DIO; 0: Non-Isolated DIO

DI\_NPN: Isolate DIO1 input NPN mode (DI\_NPN[7:0])

1: PNP (Source) mode for European rule; 0: NPN (Sink) mode for Japanese rule

DO\_NPN: Isolate DIO1 output NPN mode

1: PNP (Source) mode for European rule; 0: NPN (Sink) mode for Japanese rule

Mask: Non-isolate DIO1 out enable mask (Mask[15:0])

1: output setup; 0: input setup

Return:

TRUE (1): Success; FALSE (0): Fail (driver not work, or hardware problem)

#### **BOOL SetDIO1Config(BYTE Isolate\_Type, BYTE DI\_NPN, BYTE DO\_NPN, WORD Mask);**

Set DIO1 configuration

Isolate\_Type: DIO1 Isolate Type

1: Isolated DIO; 0: Non-Isolated DIO

DI\_NPN: Isolate DIO1 input NPN mode (DI\_NPN[7:0])

1: PNP (Source) mode for European rule; 0: NPN (Sink) mode for Japanese rule

DO\_NPN: Isolate DIO1 output NPN mode

1: PNP (Source) mode for European rule; 0: NPN (Sink) mode for Japanese rule

Mask: Non-isolate DIO1 out enable mask (Mask[15:0])

1: output setup; 0: input setup

Return:

TRUE (1): Success; FALSE (0): Fail (driver not work, or hardware problem)

**BOOL GetDI1(BYTE \*DI);**

Get Isolate DIO1 input

DI: DIO1 input (DI[7:0])

Return:

TRUE (1): Success; FALSE (0): Fail (driver not work, or hardware problem)

**BOOL GetDO1(BYTE \*DO);**

Get Isolate DIO1 output

DO: DIO1 output (DO[7:0])

Return:

TRUE (1): Success; FALSE (0): Fail (driver not work, or hardware problem)

**BOOL SetDO1(BYTE DO);**

Set Isolate DIO1 output

DO: DIO1 output (DO[7:0])

Return:

TRUE (1): Success; FALSE (0): Fail (driver not work, or hardware problem)

**BOOL GetDIO1(WORD \*DO);**

Get Non-isolate DIO1

DO: DIO1 output (DO[15:0])

Return:

TRUE (1): Success; FALSE (0): Fail (driver not work, or hardware problem)

**BOOL SetDIO1(WORD DO);**

Set Non-isolate DIO1

DO: DIO1 output (DO[15:0])

Return:

TRUE (1): Success; FALSE (0): Fail (driver not work, or hardware problem)

**BOOL GetGPIOConfig(WORD \*Mask);**

Get GPIO configuration

Mask: GPIO out enable mask (Mask[15:0])

1: output setup; 0: input setup

Return:

TRUE (1): Success; FALSE (0): Fail (driver not work, or hardware problem)

**BOOL SetGPIOConfig(WORD Mask);**

Set GPIO configuration

Mask: Non-isolate GPIO out enable mask (Mask[15:0])

1: output setup; 0: input setup

Return:

TRUE (1): Success; FALSE (0): Fail (driver not work, or hardware problem)

**BOOL GetWDT(DWORD \*WDT);**

Get watchdog timer

WDT: Watchdog timer

Return:

TRUE (1): Success; FALSE (0): Fail (driver not work, or hardware problem)

**BOOL SetWDT(DWORD WDT);**

Set watchdog timer

WDT: Watchdog timer

Return:

TRUE (1): Success; FALSE (0): Fail (driver not work, or hardware problem, or parameter format error)

**BOOL CancelWDT();**

Cancel watchdog timer

WDT: Watchdog timer

Return:

TRUE (1): Success; FALSE (0): Fail (driver not work, or hardware problem)

**BOOL GetPOEConfig(BYTE \*Mask);**

Get POE enable/disable configuration

Mask: POE enable mask (Mask[7:0])

Return:

TRUE (1): Success; FALSE (0): Fail (driver not work, or hardware problem)

**BOOL SetPOEConfig(BYTE Mask);**

Set POE enable/disable configuration

Mask: POE enable mask (Mask[7:0])

Return:

TRUE (1): Success; FALSE (0): Fail (driver not work, or hardware problem)

**BOOL GetPOE(BYTE \*POE);**

Get POE on/off setup

POE: POE switch (POE[7:0])

Return:

TRUE (1): Success; FALSE (0): Fail (driver not work, or hardware problem)

**BOOL SetPOE(BYTE POE);**

Set POE on/off setup

POE: POE switch (POE[7:0])

Return:

TRUE (1): Success; FALSE (0): Fail (driver not work, or hardware problem)

# C

## APPENDIX C : RAID Functions

### C.1 SATA Mode for RAID

Please select SATA device to RAID mode on BIOS menu.  
Advanced → SATA Configuration → SATA Mode Selection

Main	Advanced	Chipset	Boo	Security	Save & Exit	
SATA Controller(s)					[Enabled]	Item Specific Help
SATA Model Selection					[AHCI]	

### C.2 OS Installation

ECS-4500 is featured with seven SATA, include two internal SATA, two mSATA, 1 SATA DOM, 1 M2DOM, and 1 CFAST.

You can select one of SATA ports for OS installation  
We used CFAST card for Windows 10 OS installation as an example.

### C.3 Install All Device Drivers

The instructions are as follows:

1. Install Chipset driver
2. Install VGA driver
3. Install ME driver (if available)
4. Install Network driver
5. Install Audio driver

## C.4 Install Intel Rapid Storage Technology

You can get the latest information and the software directly from Intel website.

[http://www.intel.com/p/en\\_US/support/highlights/chpsts/ismm](http://www.intel.com/p/en_US/support/highlights/chpsts/ismm)

The RAID environment has been done if you completed the steps above.

## C.5 Insert SATA HDD for RAID 1

Please notice, you can use seven SATA ports for SATA storage devices.

## C.6 Create RAID Volume

ECS-4500 is featured with seven SATA storage devices for RAID volume, so there are three options for choose on this page. Let's take RAID 1 as example, please select "RAID 1".





## C.7 Disk Management : Partition the Disk

After RAID 1 volume created, you can see the figure of SATA device allocation.

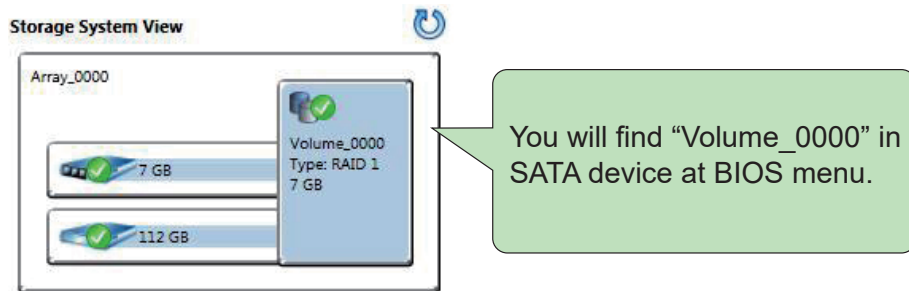

To start Disk Management tool and select "Initialize Disk", and then add "Logical Device" for Windows access.

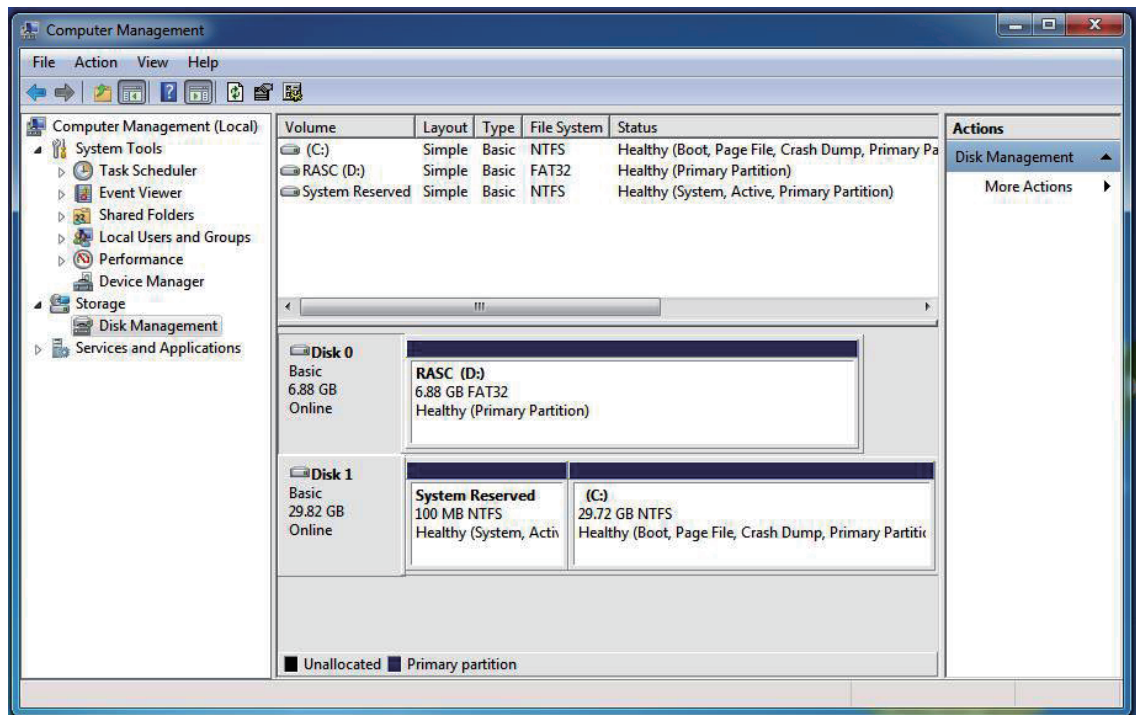

## C.8 RAID HDD Fail

After RAID 1 volume created, you can see the figure of SATA device allocation.

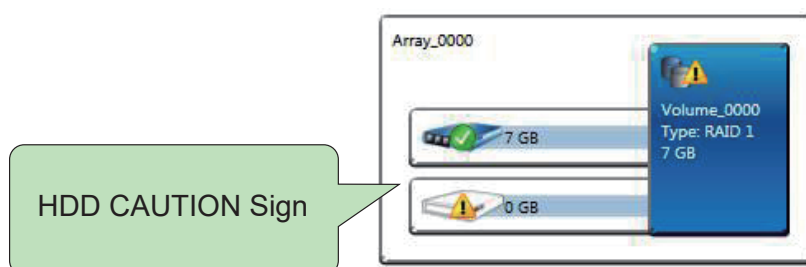

## C.9 Original HDD Recovery

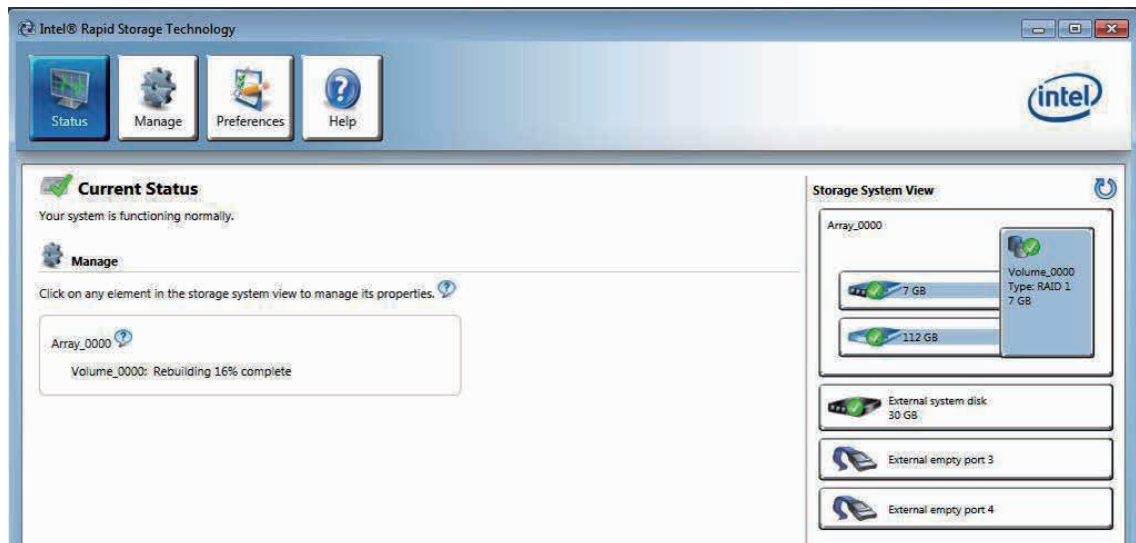

## C.10 New HDD Recovery

There is a warning will pop-up to ask you if the disk is not a member of original RAID volume. If you press “Rebuild”, it will replace the broken SATA HDD to the last one SATA HDD of RAID volume.

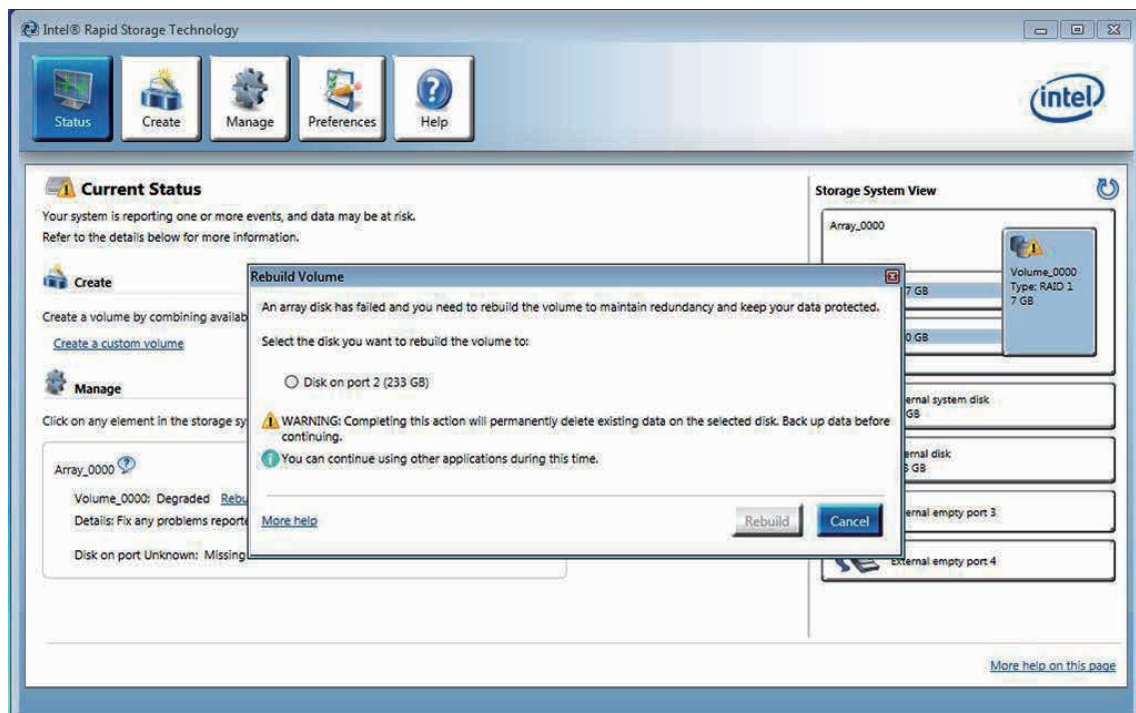

# D

## APPENDIX D : Power Consumption

Testing Board	ECS-4500
RAM	16GB X 2
USB-1	USB Keyboard Logitech K120
USB-2	USB Mouse Microsoft 1113
USB-3	USB Flash ADATA 3.0 8GB
USB-4	USB Flash ADATA 3.0 8GB
CFAST	Innodisk CFast 3ME 32GB
SATA 0	Transcend SATA SSD420 128GB
SATA 1	Seagate HDD 160GB
LAN 1 (i219)	1.0 Gbps
LAN 2 (i210)	1.0 Gbps
Graphics Output	DP
Power Plan	Balance(Windows7 Power plan)
Test Program	BurnInTest V8.1
Power Source	Chroma 62006P-100-25

## D.1 Intel® Core™ i7-6600U

### D.1.1 Intel® Core™ i7-6600U without turbo boost

Power on and boot to Win7 64bit

CPU	Power Input	Standby Mode		Sleep Mode		Idle Status : CPU usage less 3%	
		Max Current	Max Consumption	Max Current	Max Consumption	Max Current	Max Consumption
i7-6600U	06V	0.690A	04.14W	0.690A	04.14W	3.460A	20.76W
i7-6600U	09V	0.440A	03.96W	0.570A	05.13W	2.240A	20.16W
i7-6600U	12V	0.380A	04.56W	0.490A	05.88W	1.760A	21.12W
i7-6600U	24V	0.240A	05.76W	0.290A	06.96W	0.930A	22.32W
i7-6600U	36V	0.220A	07.92W	0.260A	09.36W	0.680A	24.48W

CPU	Power Input	Run 100% CPU usage without 3D		Run 100% CPU usage with 3D	
		Max Current	Max Consumption	Max Current	Max Consumption
i7-6600U	06V	4.770A	28.62W	5.420A	32.52W
i7-6600U	09V	2.870A	25.83W	3.410A	30.69W
i7-6600U	12V	2.210A	26.52W	2.730A	32.76W
i7-6600U	24V	1.180A	28.32W	1.350A	32.40W
i7-6600U	36V	0.820A	29.52W	0.980A	35.28W

### D.1.2 Intel® Core™ i7-6600U with turbo boost

Power on and boot to Win7 64bit

CPU	Power Input	Standby Mode		Sleep Mode		Idle Status : CPU usage less 3%	
		Max Current	Max Consumption	Max Current	Max Consumption	Max Current	Max Consumption
i7-6600U	06V	0.700A	04.20W	0.890A	05.34W	3.420A	20.52W
i7-6600U	09V	0.450A	04.05W	0.570A	05.13W	2.190A	19.71W
i7-6600U	12V	0.390A	04.68W	0.500A	06.00W	1.790A	21.48W
i7-6600U	24V	0.240A	05.76W	0.295A	07.08W	0.870A	20.88W
i7-6600U	36V	0.220A	07.92W	0.250A	09.00W	0.680A	24.48W

CPU	Power Input	Run 100% CPU usage without 3D		Run 100% CPU usage with 3D	
		Max Current	Max Consumption	Max Current	Max Consumption
i7-6600U	06V	5.350A	32.10W	5.780A	34.68W
i7-6600U	09V	3.410A	30.69W	4.060A	36.54W
i7-6600U	12V	2.670A	32.04W	3.230A	38.76W
i7-6600U	24V	1.420A	34.08W	1.610A	38.64W
i7-6600U	36V	0.980A	35.28W	1.130A	40.68W

## D.2 Intel® Core™ i5-6300U

### D.2.1 Intel® Core™ i5-6300U without turbo boost

Power on and boot to Win7 64bit

CPU	Power Input	Standby Mode		Sleep Mode		Idle Status : CPU usage less 3%	
		Max Current	Max Consumption	Max Current	Max Consumption	Max Current	Max Consumption
i5-6300U	06V	0.700A	04.20W	0.900A	05.40W	3.690A	22.14W
i5-6300U	09V	0.450A	04.05W	0.580A	05.22W	2.260A	20.34W
i5-6300U	12V	0.390A	04.68W	0.500A	06.00W	1.820A	21.84W
i5-6300U	24V	0.240A	05.76W	0.300A	07.20W	0.940A	22.56W
i5-6300U	36V	0.230A	08.28W	0.260A	09.36W	0.650A	23.40W

CPU	Power Input	Run 100% CPU usage without 3D		Run 100% CPU usage with 3D	
		Max Current	Max Consumption	Max Current	Max Consumption
i5-6300U	06V	4.700A	28.20W	5.540A	33.24W
i5-6300U	09V	2.940A	26.46W	3.360A	30.24W
i5-6300U	12V	2.270A	27.24W	2.580A	30.96W
i5-6300U	24V	1.150A	27.60W	1.280A	30.72W
i5-6300U	36V	0.820A	29.52W	0.920A	33.12W

### D.2.2 Intel® Core™ i5-6300U with turbo boost

Power on and boot to Win7 64bit

CPU	Power Input	Standby Mode		Sleep Mode		Idle Status : CPU usage less 3%	
		Max Current	Max Consumption	Max Current	Max Consumption	Max Current	Max Consumption
i5-6300U	06V	0.700A	04.20W	0.890A	05.34W	3.700A	22.20W
i5-6300U	09V	0.440A	03.96W	0.570A	05.13W	2.300A	20.70W
i5-6300U	12V	0.390A	04.68W	0.490A	05.88W	1.800A	21.60W
i5-6300U	24V	0.240A	05.76W	0.300A	07.20W	0.950A	22.80W
i5-6300U	36V	0.230A	08.28W	0.260A	09.36W	0.690A	24.84W

CPU	Power Input	Run 100% CPU usage without 3D		Run 100% CPU usage with 3D	
		Max Current	Max Consumption	Max Current	Max Consumption
i5-6300U	06V	5.140A	30.84W	6.120A	36.72W
i5-6300U	09V	3.510A	31.59W	4.000A	36.00W
i5-6300U	12V	2.470A	29.64W	2.940A	35.28W
i5-6300U	24V	1.280A	30.72W	1.520A	36.48W
i5-6300U	36V	0.910A	32.76W	1.030A	37.08W

## D.3 Intel® Celeron® 3955U

Power on and boot to Win7 64bit

CPU	Power Input	Standby Mode		Sleep Mode		Idle Status : CPU usage less 3%	
		Max Current	Max Consumption	Max Current	Max Consumption	Max Current	Max Consumption
3955U	06V	0.690A	04.14W	0.880A	05.28W	3.530A	21.18W
3955U	09V	0.450A	04.05W	0.580A	05.22W	2.270A	20.43W
3955U	12V	0.390A	04.68W	0.500A	06.00W	1.790A	21.48W
3955U	24V	0.240A	05.76W	0.300A	07.20W	0.940A	22.56W
3955U	36V	0.240A	08.64W	0.260A	09.36W	0.690A	24.84W

CPU	Power Input	Run 100% CPU usage without 3D		Run 100% CPU usage with 3D	
		Max Current	Max Consumption	Max Current	Max Consumption
3955U	06V	4.140A	24.84W	5.400A	32.40W
3955U	09V	2.710A	24.39W	3.580A	32.22W
3955U	12V	2.100A	25.20W	2.650A	31.80W
3955U	24V	1.080A	25.92W	1.370A	32.88W
3955U	36V	0.780A	28.08W	0.990A	35.64W

# E

## APPENDIX E : Supported Memory & Storage List

### E.1 Supported Memory List

Testing Board	ECS-4500
CPU	i7-6600U
Memory Test	version: 5.1
BurnInTest	V8.1

### E.2 Tset Item

Channel	Memtest	Bunin	Flash BIOS	Remove Battery
*2	PASS	PASS	PASS	PASS
*1(Socket 1)	PASS	PASS	N/A	PASS
*1(Socket 2)	PASS	PASS	N/A	PASS

Brand	Info	NOTE & S\N	Test Temp. (Celsius)
Transcend 8GB	8G 2Rx8 DDR4 2133 SO	TS9CASESE0000	25°C
		D28506-0015	25°C
		D28506-0016	25°C
Transcend 16GB	16G 2Rx8 DDR4 2133 SO	TS0CAMGSE000	25°C
		C97147-0001	25°C
		C97147-0001	25°C

Kingston 8GB	8GB 1Rx8 1G x 64-Bit PC4-2133 CL15 260-Pin SODIMM	KVR21S15S8/8	25°C
		BTMM0881692	25°C
		BTMM0881602	25°C
Kingston 16GB	16GB 2Rx8 2G x 64-Bit PC4-2133 CL15 260-Pin SODIMM	KVR21S15D8/16	25°C
		BKMM1661618	25°C
		BSMM1641607	25°C
MEMXPRO 16GB	16GB DDR4-2400-17 SODIMM IT	D4SAGHLPGFI	25°C
		O1611150030001	25°C
		O1611150030002	25°C
Transcend 4GB	4G 1Rx8 DDR4 2400 SO	TS8CBSESE0000	25°C
		C96643-0001	25°C
		C96643-0002	25°C

## E.2 Supported Storage Device List

Type	Vendor	Model	Capacity
mSATA	Intel	Intel-310 SSDMAEMC080G2	80GB
	innodisk	mSATA 3ME3 DEMSR-64GD09BW2DC	64GB
		mSATA 3ME3 DEMSR-A28D09BW2DC	128GB
		mSATA 3ME3 DEMSR-B56D08BWBQC	256GB
SATA SSD	Transcend	SSD420 TS128GSSD420I	128GB
		SSD420 TS256GSSD420I	256GB
		SSD370 TS64GSSD370	64GB
	Intel	SSD 540s SSDSC2KW180H6	180GB
		SSD E 5400s SSDSC2KR120H6	120GB
		SSD 530 SSDSC2BW120A4	120GB
SATA HDD	TOSHIBA	MQ01ABF050	500GB
	HGST	Z5K500.B-500	500GB

\*\* If more help is needed, please contact Vecow technical support \*\*



# F

## APPENDIX F : Install Win11 (BIOS TPM Setting)

**Step 1** Click on “Advanced”, then click on “PCH-FW Configuration”

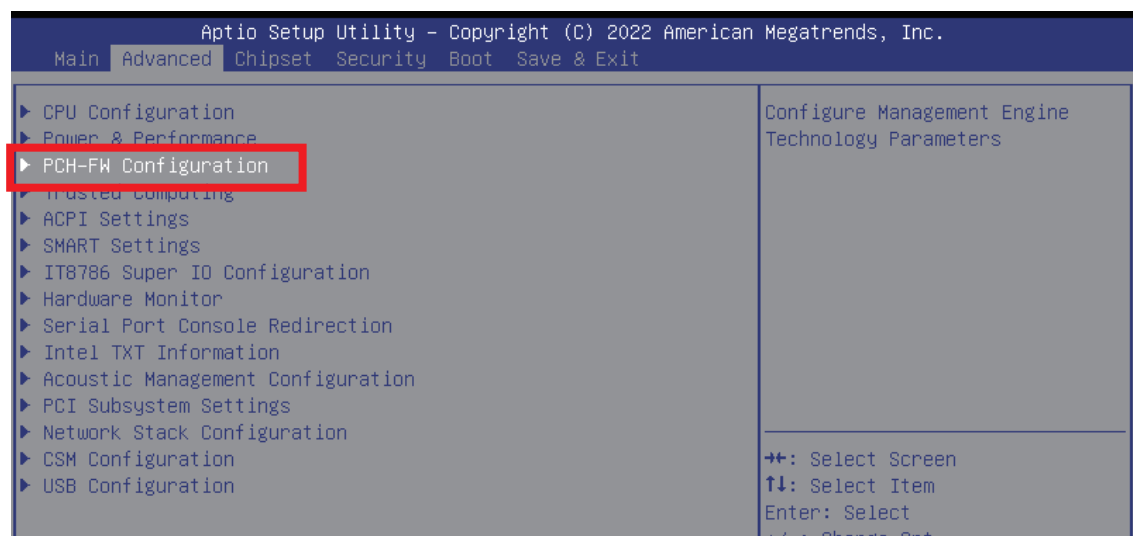

**Step 2** Click on “PTT Configuration”

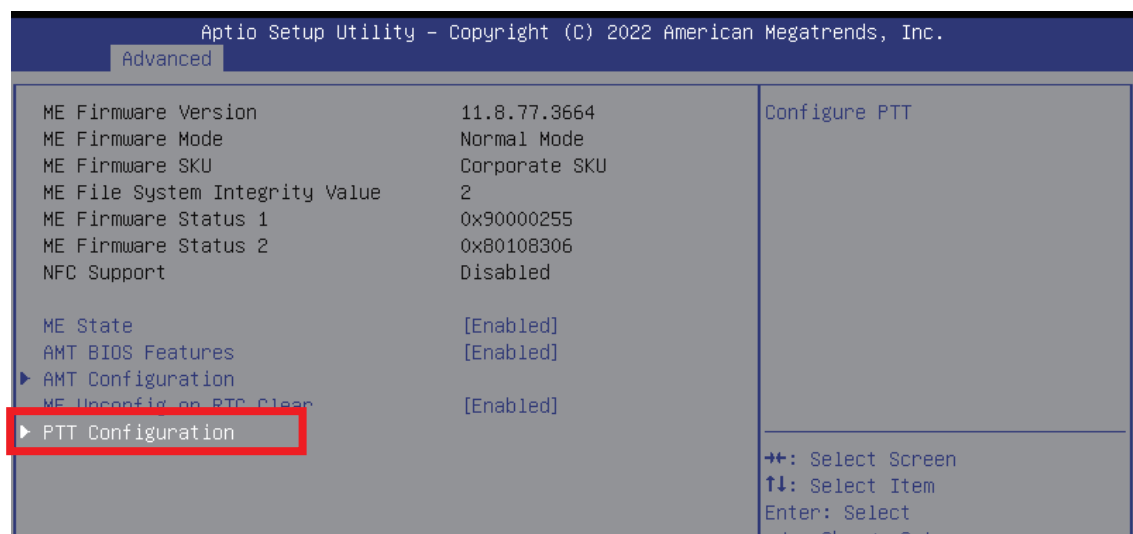

**Step 3** Click on “dTPM” (TPM Device Selection)

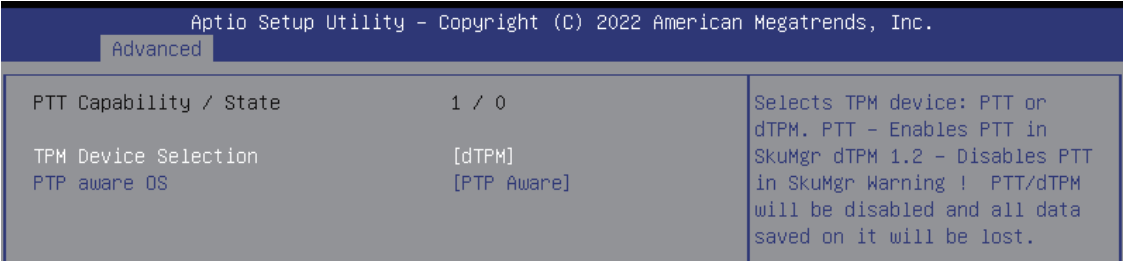
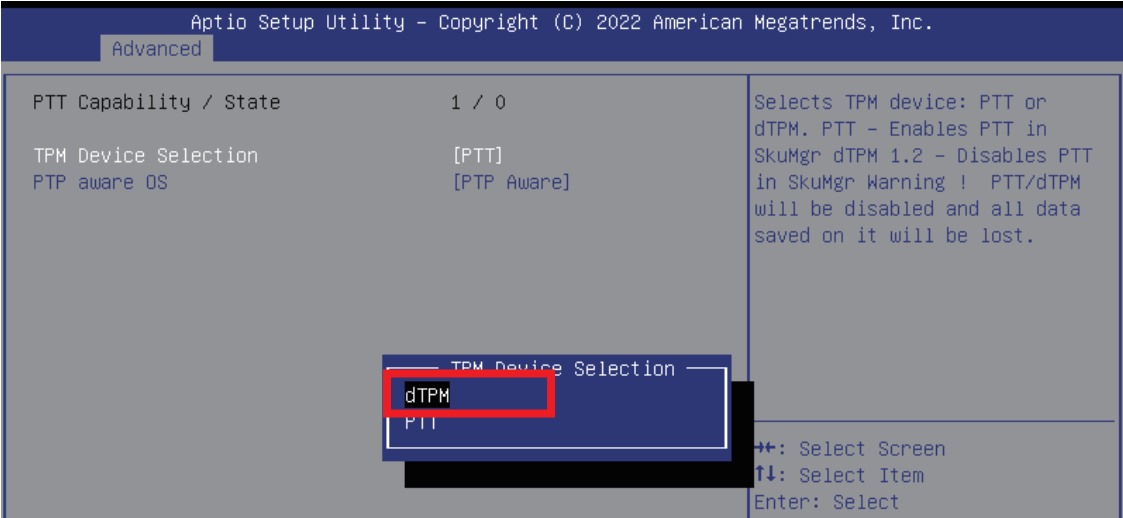

**Step 4** Please save the BIOS settings by pressing F4. Please press Enter when the pop-up window which asks “Save configuration and exit?” appears. The computer will then restart.

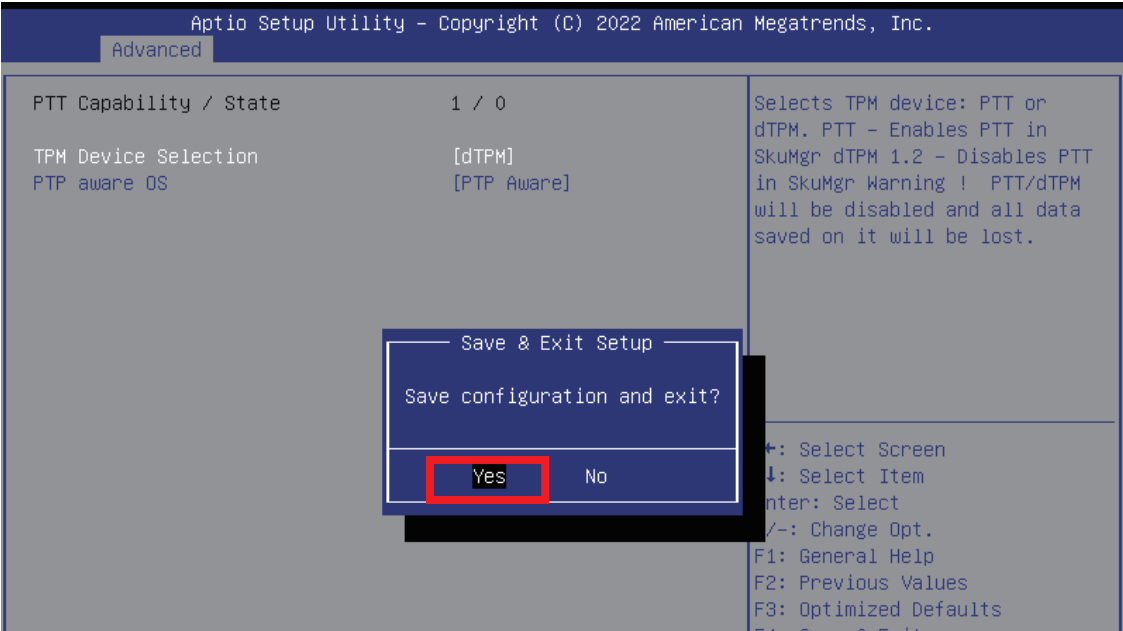

### Step 5 Click on “Trusted Computing”

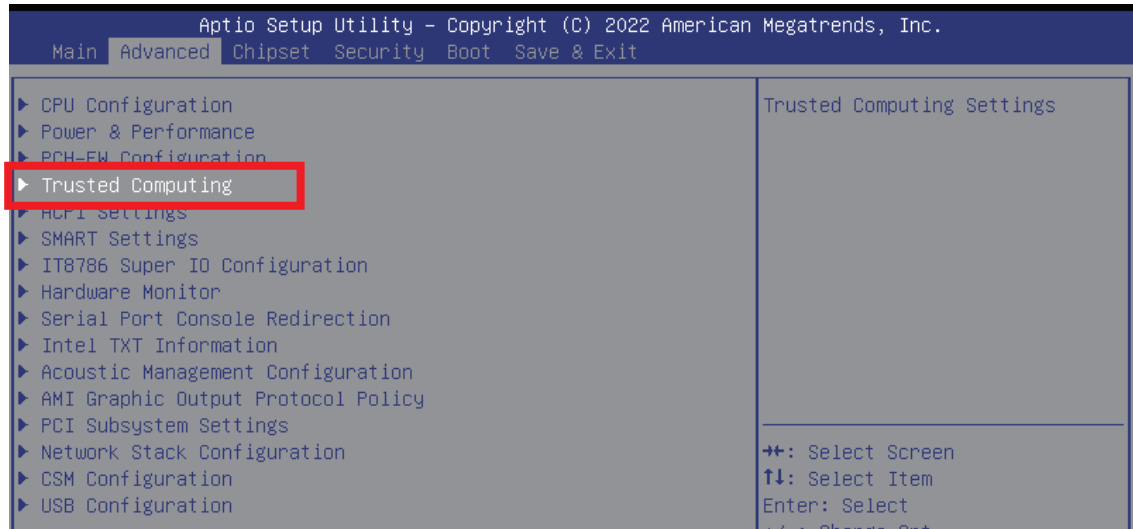

### Step 6 If the window shows “TPM2.0 Device Found Firmware Version:5.62”, then the setting is completed.

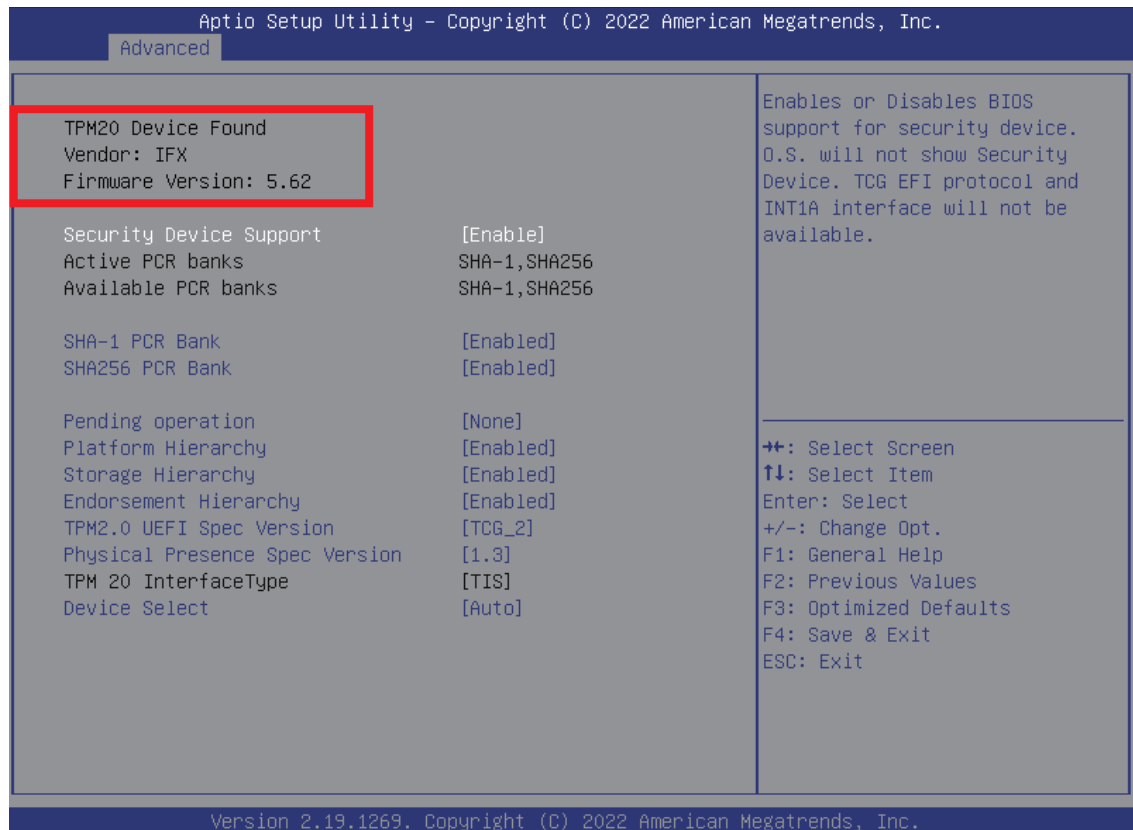

\*\* If more help is needed, please contact Vecow technical support \*\*



For further support information, please visit [www.vecow.com](http://www.vecow.com)

This document is released for reference purpose only.

All product offerings and specifications are subject to change without prior notice.

No part of this publication may be reproduced in any form or by any means, electric, photocopying, or recording, without prior authorization from the publisher.

The rights of all the brand names, product names, and trademarks belong to their respective owners.

© Vecow Co., Ltd. 2023. All rights reserved.